

MAHLE ACX1150/ACX1150H

EN

Operation manual
A/C Service Units



Contents

1. Symbols use	4	7. Setup	18
1.1 In the documentation	4	7.1 ACX1150	18
1.1.1 Warning notices—Structure and meaning	4	7.1.1 EcoLOCK	18
1.1.2 Symbols in this documentation	4	7.1.2 Recharge mode	18
1.2 On the product	4	7.1.3 Pressure check	18
		7.1.4 Multipass	18
		7.1.5 Recovered refrigerant and oil printing	18
		7.1.6 Report saving mode	18
		7.1.7 Report data	18
		7.1.8 Unit of measure	19
		7.1.9 Clock adjustment	19
		7.1.10 Garage data	19
		7.1.11 Setting language	19
		7.1.12 Startup screen	19
		7.1.13 Default setup	19
2. Important notes	4		
2.1 User group	4		
2.2 Agreement	4		
2.3 Obligation of contractor	5		
2.4 Safety regulations	6		
2.4.1 ACX1150	6		
2.5 Safety devices	7		
3. Product description	8	8. A/C service preparation	20
3.1 Application	8	8.1 Preliminary operations	20
3.2 Scope of delivery	8	8.2 Non-condensable gas discharge	20
3.3 Description of unit	9	8.3 Charge modes	21
3.4 User interface	10	8.3.1 Quick mode	21
3.4.1 Selection and function keys	10	8.3.2 Zero tolerance mode	21
3.4.2 Input selection	11		
3.4.3 Entering text	11	9. A/C system service	22
3.4.4 Display screen - Main menu	11	9.1 Automatic cycle setup	22
3.4.5 Main menu options	11	9.1.1 Database	22
3.5 Unit features	12	9.1.2 Last cycle	22
3.5.1 EcoLOCK® quick couplers	12	9.1.3 My database	22
3.5.2 Locking caster brakes	12	9.2 Automatic cycle	22
3.5.3 Power supply cable and switch	12	9.2.1 Vacuum	22
3.6 Functional description	12	9.2.2 Oil	22
		9.2.3 Refrigerant	23
		9.2.4 Couplers	23
		9.2.5 Electric compressor function (ACX1150H only)	23
4. Technical features	13	9.3 Manual cycles	24
		9.3.1 Recovery process	24
		9.3.2 Vacuum process	24
		9.3.3 Recharge	25
		9.3.4 Flushing (with optional accessories)	25
		9.3.5 Pressure check	26
		9.3.6 Hose emptying	26
5. Equipment installation	14		
5.1 Unpacking ACX1150	14		
5.2 Load cell screw release	15		
6. Commissioning	16		
6.1 Connections and positioning	16		
6.2 First start-up verification	16		
6.3 New oil bottle filling (not available on H model units)	17		
6.4 UV dye bottle filling (not available on H model units)	17		

10. Maintenance	27
10.1 Maintenance interval and overview	27
10.2 Filling internal refrigerant cylinder	27
10.3 Self leak test	28
10.4 Cylinder refrigerant view	28
10.5 Recovered oil weight zero (tare)	28
10.6 Pressure zero	29
10.7 Counters	29
10.8 Long life pump test	29
10.9 Vacuum pump oil change	30
10.10 Replace filter dryer	31
10.11 Multipass	32
10.12 System info	32
10.13 Software update	32
10.14 Refrigerant weight accuracy check	33
10.15 Printer maintenance	34
10.16 Periodic checks	34
11. Spare parts	35
12. Disposal	35
12.1 A/C Service unit disposal	35
12.2 Recycled material disposal	35
12.3 Packaging disposal	35
13. Troubleshooting	36
13.1 ACX1150	36
14. Maintenance forms	38
14.1 Vacuum pump oil change	38
14.2 Filter dryer change	40
14.3 Refrigerant load cell calibration check	43
14.4 Other checks/maintenance/repairs	45
15. Notes	47

1. Symbols use

1.1 In the documentation

i To avoid repeating both models ACX1150 and ACX1150H in the text, ACX1150 will be used as a common name. If not explicitly indicated for the H model, ACX1150H, instructions are common to both models ACX1150 and ACX1150H.

1.1.1 Warning notices—Structure and meaning

Warning notices warn of dangers to the user or people in the vicinity. Warning notices also indicate the consequences of the hazard as well as preventive action. Warning notices have the following structure:

Warning symbol **KEY WORD – Nature and source of hazard!**
Consequences of hazard in the event of failure to observe action and information given.
 ➤ Hazard prevention action and information.

The key word indicates the likelihood of occurrence and the severity of the hazard in the event of non-observance:

Key word	Probability of occurrence	Severity of danger if instructions not observed
DANGER	Immediate danger impending	Death or severe injury
WARNING	Possible danger impending	Death or severe injury
CAUTION	Possible dangerous situation	Minor injury

1.1.2 Symbols in this documentation

Symbol	Designation	Explanation
	Attention	Warns about possible property damage.
	Information	Practical hints and other useful information.
1. 2.	Multi-step operation	Instruction consisting of several steps.
➤	One-step operation	Instruction consisting of one step.
⇨	Intermediate result	An instruction produces a visible intermediate result.
➔	Final result	There is a visible final result on completion of the instruction.

1.2 On the product

Observe all warning notices on products and ensure they remain legible.



➤ Wear protective goggles.



➤ Wear protective gloves.

2. Important notes



Before start up, connecting and operating MAHLE products it is absolutely essential that the Original instructions/owner’s manual and, in particular, the safety instructions are studied carefully. By doing so you can eliminate any uncertainties in handling MAHLE products and thus associated safety risks upfront; something which is in the interests of your own safety and will ultimately help avoid damage to the device. When a MAHLE product is handed over to another person, not only the Original instructions but also the safety instructions and information on its designated use must be handed over to the person.

2.1 User group

The product may be used by skilled and instructed personnel only. Personnel scheduled to be trained, familiarized, instructed or to take part in a general training course may only work with the product under the supervision of an experienced person.

All work conducted on pressurized equipment may be performed by persons with sufficient knowledge and experience in the field of refrigeration, cooling systems and coolants and, also be aware of the risks involved in the use of pressurized devices.

2.2 Agreement

By using the product you agree to the following regulations:

Copyright

Software and data are the property of MAHLE or its suppliers and protected against copying by copyright laws, international agreements and other national legal regulations. Copying or selling of data and software or any part thereof is impermissible and punishable; in the event of any infringements MAHLE reserves the right to proceed with criminal prosecution and to claim for damages.

Liability

All data in this program is based—where possible—on manufacturer and importer details. MAHLE does not accept liability for the correctness and completeness of software and data; liability for damage caused by faulty software and data is ruled out. Whatever the event, MAHLE liability is restricted to the amount for which the customer actually pays for this product. This disclaimer of liability does not apply to damages caused by intent or gross negligence on the part of MAHLE.

Warranty

Any use of non-approved hardware and software will result in a modification to our product and thus to exclusion of any liability and warranty, even if the hardware or software has in the meantime been removed or deleted.

No changes may be made to our products. Our products may only be used in combination with original accessories and original service parts. Failing to do so, will render null and void all warranty claims.

This product may only be operated using MAHLE approved operating systems. If the product is operated using an operating system other than the approved one, then our warranty obligation pursuant to our supply conditions will be rendered null and void. Furthermore, we will not be held liable for damage and consequential damage incurred through the use of a non-approved operating system.

2.3 Obligation of contractor

The contractor is obliged to ensure that all measures geared towards the prevention of accidents, industrial diseases, labor-related health risks are taken and measures towards making the workplace fit for people to work in are carried out.

Specifications for electrical systems

Electrical engineering in Germany is subject to the accident prevention regulations of the trade association "Electrical Plant and Equipment as under BGV A3 (previously VBG 4)". In all other countries, the applicable national regulations acts or decrees are to be adhered to.

Basic rules

The contractor is bound to ensure that all electrical equipment and operating material is set up, modified and maintained by skilled electricians only or under the guidance and supervision of a skilled electrician in accordance with electrical engineering principles.

Furthermore, the contractor must ensure that all electrical equipment and operating material is operated in keeping with electrical engineering principles.

If a piece of electrical equipment or operating material is found to be defective, i.e. it does not or no longer complies with electrical engineering principles, the contractor must ensure that the fault is rectified immediately and, in the event that imminent danger exists, also ensure that the electrical equipment or the electrical operating material is not used.

2.4 Safety regulations

2.4.1 ACX1150

Always carefully study and follow all the safety regulations before using the MAHLE product.



Avoid all skin contact with the refrigerant. The low boiling point of the refrigerant (approx. $-30\text{ }^{\circ}\text{C}$) can lead to frostbite. Should refrigerant come into contact with the skin, remove any moistened clothing immediately and rinse the area of skin affected with generous amounts of water.

- Avoid all skin contact with the UV dye. Should UV dye come into contact with the skin, remove any moistened clothing immediately and rinse the area of skin affected with generous amounts of water.
- R134a is colorless, with weak characteristic smell and heavier than air. It may flow into repair pits. Should refrigerant escape, provide for sufficient ventilation (particularly in repair pits) and leave the workshop.



Never inhale refrigerant, dye and oil vapors. The vapors can irritate the eyes, nose and respiratory system. If liquid refrigerant or UV dye comes into contact with the eyes, rinse them thoroughly with water for 15 minutes. Then obtain medical attention even if no pain is felt.

- Never swallow UV dye. Should it be swallowed inadvertently, never attempt to induce vomiting. Drink generous amounts of water and obtain medical attention.
- Before connecting the ACX1150 to a vehicle air conditioning system or an external refrigerant bottle, make sure the quick-release couplings are not leaking. Only ever use external refrigerant bottles provided with safety valves and certified inline with the applicable standards.
- Before switching off the ACX1150, make sure all charging and drainage operations have been completed. This prevents damage to the unit and reduces risk of refrigerant escaping into the environment.



Never use compressed air with R134a. Certain mixtures of air and R134a are highly flammable. Such mixtures are a potential hazard and may lead to fire or explosions and thus cause damage or injury.

- Refrigerant extracted from a vehicle air conditioning system may be contaminated with moisture, lubricant, dirt and traces of other gases.
- If the refrigerant has been contaminated by being mixed with other gases, remove the contaminated refrigerant and add fresh R134a before using the ACX1150 for A/C service.
- R134a is not to be used in areas in which there is a danger of explosion. Fire, open flames and smoking are prohibited. Welding and soldering are not permitted.
- The ACX1150 unit should not be exposed to excess moisture or be operated in wet areas.
- R134a is not to be mixed with other refrigerants. The mixing of refrigerants could damage the vehicle air conditioning system.



If high-voltage components or high-voltage wires are handled incorrectly, there is a risk of fatal injury from high voltage and the possible transmission of current through the body.

- De-energizing is only to be performed by a qualified electrician, a qualified electrician for specific tasks (hybrid) or a power systems engineer.
- Work on vehicles with high-voltage components is only ever to be performed in a safe, de-energized condition by persons with the minimum qualification "Trained to perform electrical work".
- Even after deactivating a high-voltage vehicle electrical system, the high-voltage battery may still be live.
- Operating condition cannot be established from any running noise, as the electric machine is silent when stationary.
- In gear positions "P" and "N" the engine or electric motor may start spontaneously depending on the charge of the high-voltage battery.
- Never open or damage high-voltage batteries.
- On vehicles that have been in an accident, never touch high-voltage components or exposed high-voltage wires before deactivating the high-voltage vehicle electrical system.
- The ACX1150 must be constantly monitored when in operation. Never leave the ACX1150 unattended when in operation.
- Vehicle A/C service using the ACX1150 must be prepared and implemented such that the vehicle air conditioning system circuit does not have to be opened (for example by removing the radiator or engine).
- Position the ACX1150 on all four wheels on a flat, vibration-proof surface so that proper operation of the scales is guaranteed.
- The ACX1150 can be secured in position by locking the caster brake.

- The ACX1150 must always be transported in its operating position. Never lay the ACX1150 on its side, as oil could then escape from the vacuum pump or the built in compressor could be damaged.
 - There are no additional safety systems for protecting the ACX1150 against damage resulting from natural catastrophes.
 - Never remove any components from inside the ACX1150 except for maintenance or repair purposes.
 - Follow the pertinent legal regulations or directives to ensure safe handling of pressurized devices.
 - We recommend calibrating the scales at least once per year. Contact customer service for calibration of the scales.
 - The ACX1150 must be subjected to regular maintenance by service personnel or authorized agents to ensure the safety of the unit.
 - Disconnect power before performing any maintenance or service to unit.
 - Never perform any maintenance work which is not expressly recommended in this manual. Contact customer service if components have to be replaced other than in the course of maintenance work.
 - ACX1150 must be connected to a properly grounded electrical connection.
 - If there is damage to the ACX1150, terminate usage immediately and contact customer service.
 - The service hoses and service quick-release couplings must be regularly checked for wear and replaced if damaged.
 - The ACX1150 must be operated in an environment corresponding to the directive BGR 157 with respect to the exchange of air.
 - Observe local laws or directives as to ensure the safety of the pressurized device.
- For safety reasons it is advisable to use a residual current operated circuit breaker (rccb) with the following specifications:

Parameters	Specification
Rated voltage	110 VAC \pm 10%
Rated frequency	50/60Hz
Rated current	10A
Rated tripping current	30mA
Tripping switch	C

2.5 Safety devices

Description	Function
Pressure switch	Switches the compressor off if the normal operating pressure is exceeded.
Safety valve	The safety valve opens if the design pressure is exceeded.
Circuit breaker	Interrupts the power supply if overcurrent is applied to the ACX1150.
Vents	The ACX1150 is provided with vents in the bottom of the housing to ensure the exchange of air even when switched off.

3. Product description

3.1 Application

ACX1150 is suitable for vehicles with a conventional engine. The ACX1150H is suitable for vehicles with a conventional engine as well as for hybrid and electric vehicles. Both include all the functions required for vehicle A/C service.

The following functions can be implemented:

- Refrigerant recovery and recharging.
- Vacuum generation.
- Flushing.

⚠ The ACX1150 can only be operated with R134a. The ACX1150 is not to be used for service work on vehicles with air conditioning systems employing refrigerants other than R134a, as this will cause damage. Prior to A/C service check the type of refrigerant used in the vehicle air conditioning system.

3.2 Scope of delivery

Description
Service hose (high pressure)
Service hose (low pressure)
Quick-release coupling (high pressure)
Quick-release coupling (low pressure)
Used oil bottle
New oil bottle (not included with H model)
UV dye bottle (not included with H model)
Original instructions
Adapter (external bottle) - US Acme 1/2
Calibration check weight
Hose flushing adapter (built into unit on H model)

3.3 Description of unit

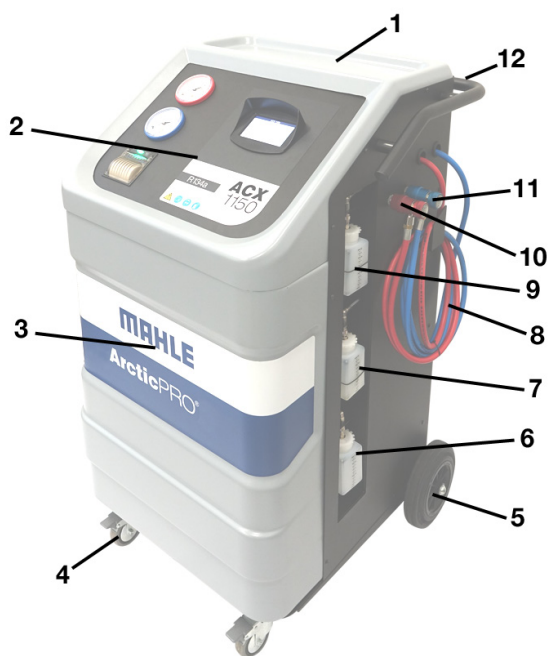

Fig. 1: Front left view

- 1 Tool tray and storage
- 2 Display and operating unit
- 3 ACX1150 front housing
- 4 Locking caster
- 5 Rear wheel
- 6 Used oil bottle
- 7 UV dye bottle
- 8 Service hoses (not included on H model unit)
- 9 New oil bottle (not included on H model unit)
- 10 High-side parking coupler
- 11 Low-side parking coupler
- 12 Rear handle and grip

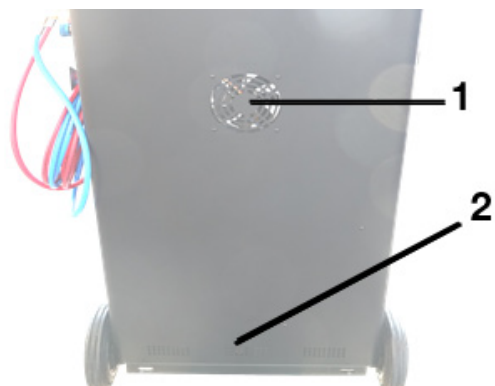

Fig. 2: Rear view

- 1 Fan
- 2 Vents



Fig. 3: Right-front view

- 1 Power cord connector
- 2 Power switch
- 3 USB type B (Device port to PC)
- 4 USB type A (USB memory stick port)

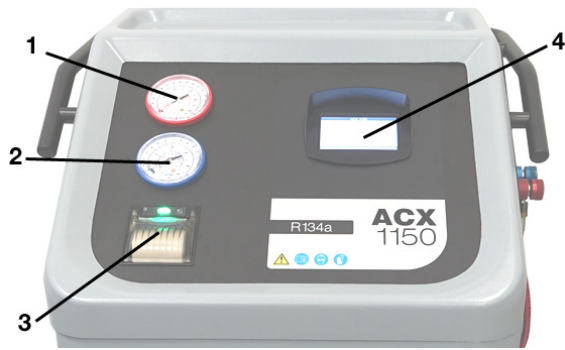

Fig. 4: Display and operating unit

- 1 High-pressure gauge
- 2 Low-pressure gauge
- 3 Printer (optional accessory)
- 4 LCD touchscreen

The pressure gauges (Fig. 4, Pos. 1, 2) of the display and operating unit are used to monitor the pressure during the individual vehicle A/C service phases. The status of the various service phases during maintenance is displayed on the LCD screen (Fig. 4, Pos. 4).

The menu selection and necessary entries are made by way of the touch screen LCD (Fig. 4, Pos. 4).

If a situation arises where the unit software requires updated, MAHLE has a USB stick available for updating the ACX1150 software. The USB stick can be inserted in the USB socket to perform updating of the firmware/software.

3.4 User interface

3.4.1 Selection and function keys

All settings, controls and service functions are available on the LCD touch display. Data entry and moving of the cursor is performed with user's finger or some other object such as a pen or stylus. The LCD displays the service equipment's status, the progress of A/C system service and any alarms/error messages. When a button is pressed, a beep sounds.

⚠ Do not use a sharp, pointed object on the touch screen. Damage may occur!

The following function keys are available:

Keys	Name	Function
	Up	To move up in the menu options or data field
	Down	To move down in the menu options or data field
	Scroll bar	To move up/down in the menu options
	Data value	Arrows to decrease/increase data value
	Press to change	To modify the data or switch data to next option
	Back	To return to previous page
	Save	To save the programmed cycle in a personal memory
	Ok	To confirm and continue
	Start	To begin a cycle or process
	No	To answer NO to the displayed message
	Yes	To answer YES to the displayed message
	Abort	To interrupt the operation in progress

3.4.2 Input selection

To select a function in the menu, press the text name of the function and the selection occurs when finger is released. The selected entry is highlighted with a different color (from grey to blue) and the menu screen page changes.

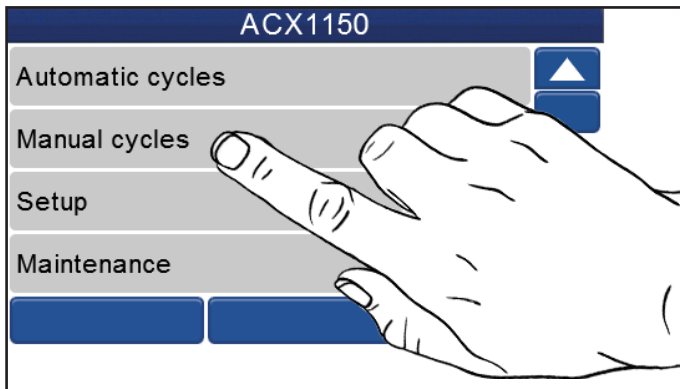

Fig. 5: Selecting items on screen

❶ If there are menus that cannot fit on one screen, there will be a scroll bar located on the right-hand side of the screen. By placing finger on the scroll bar button and moving finger up or down, screen options will also move. By touching the arrows at the top and bottom of the scroll bar, the screen will move up or down 1 line at a time.

3.4.3 Entering text

If text needs to be entered on the display, a keyboard will automatically appear (i.e. for entering workshop data (if printer is present) or at the end of the service cycle).

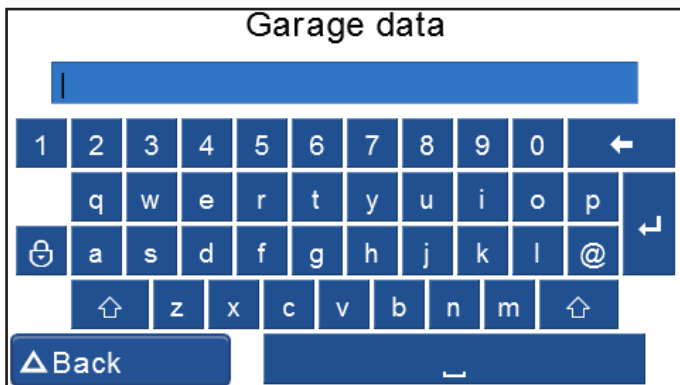

Fig. 6: Keyboard for data entry

If this key is active -  - it is possible to switch to the symbols keyboard.

3.4.4 Display screen - Main menu

When unit loads, the total refrigerant weight screen will be displayed. Tap screen to go to main menu as displayed in Fig. 7.

To select a function in the menu, press ▲ or ▼ to scroll to name of the desired function. Touch the desired selection to enter that function.

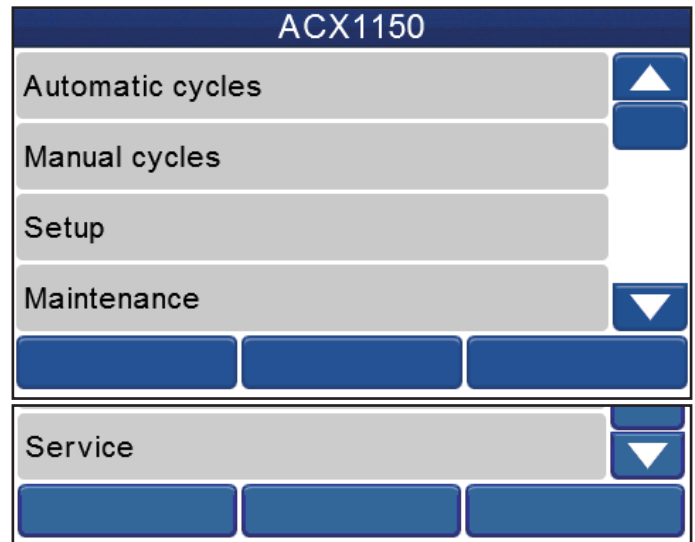

Fig. 7: Main menu screen

3.4.5 Main menu options

The main menu of the graphical user interface allows user to select the following functions:

- Automatic cycles
- Manual cycles
- Setup
- Maintenance
- Service

Each of the menu options will be described in detail later in the manual.

3.5 Unit features

3.5.1 EcoLOCK® quick couplers

EcoLOCK® is the intelligent coupler, that with the suitable automated procedure in the software enables to:

- reduce the amount of non-condensable gases formed inside the cylinder,
- avoid the refrigerant (loss) dispersion in the air during the disconnection of the couplers (puff-effect),
- check possible Schrader valve leaks before disconnection.



Fig. 8: EcoLOCK® couplers

To connect the coupling, position the coupling on the parking coupler, pull back the knurled section of the coupling element and press carefully onto the connection (Fig. 9).

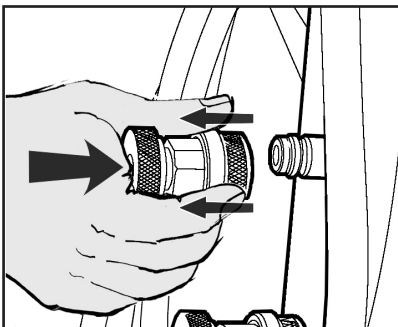

Fig. 9: Fastening quick-release coupling

i The service quick-release couplings are connected to the service connections of the vehicle air conditioning system during A/C service. When not in use, the service quick-release couplings can be connected to the parking/flush couplers.

i To remove the service quick-release couplings from the parking/flush coupler, press the coupling slightly towards the connection and carefully pull the knurled section back to unfasten it from the coupler.

3.5.2 Locking caster brakes

Rolling of the ACX1150 can be prevented by locking the caster brakes (Fig. 1, Pos. 4) at the front wheels.

3.5.3 Power supply cable and switch

The power supply cable is connected to the main power input. When not in operation, the power supply cable can be disconnected and hung on the handle. The ACX1150 is switched on by toggling the rocker switch to the on position.

3.6 Functional description

The refrigerant recovered from the air conditioning system passes through the combo filter to remove suspended particles and moisture.

The purpose of the vacuum pump is to generate a vacuum in the air conditioning system which removes excess moisture and to detect possible leaks in the vehicle air conditioning system.

Used oil is separated from the refrigerant recovered out of the vehicle and then drained into the used oil bottle during the recovery process.

The vehicle air conditioning system is partly filled with UV dye to facilitate the detection of leaks in the event of damage to the vehicle air conditioning system.

The refrigerant in the internal refrigerant bottle is used for filling the vehicle air conditioning system.

The purging unit for the non-condensable gases, consisting of a temperature sensor, pressure sensor, coil and orifice, always takes effect when the internal refrigerant bottle pressure is higher than the saturation pressure.

4. Technical features

Description	Specification
R134a tank capacity	12L
Service pressure	400PSI
Maximum content	22lbs
Method to weigh gas content	Load cell
Recovered oil container	250ml
New PAG oil container	250ml w/ Oil Care valve-not on H model units
UV tracer container capacity	250ml w/ Oil Care valve-not on H model units
Vacuum pump	1.8CFM dual stage
Vacuum pump oil quantity	250ml
Compressor capacity	0.87cu in/14cc
Dryer filter	75kg of recovered R134a
Non-condensable gas purge	Automatic via solenoid valve
HP and LP taps	Automatic
Pressure switch type	13 / 18bar 1/4 SAE
Pressure switch trip pressure	18bar
HP/LP hose lengths	3m
HP & LP pressure gauges	Analog, 80mm, pulse free, 1.0 class
Low side max pressure	217PSI
High side max pressure	261PSI
Display	4,3" TFT Widescreen 480x272, 65536 colors
Keypad	Touch screen
Software updating	USB type A /USB type B direct connect to PC
Printer (optional)	Thermal, 24 columns
All functions	Automatic and manual
Recycling mode	Single or multipass
Memory for customized cycles	100 records
Recovered oil measurements	Automatic weigh, 1g res., 5g accuracy
New oil automatic injection (not available on H model unit)	With auto scale, 1g res. 5g accuracy
UV tracer automatic injection (not available on H model unit)	Timed
Electric compressor function	With integrated flushing system
Flushing	With integrated solenoid valves
Database	Autodata, electronic (cars/passenger only)
System pressure diagnostics	Manual and automatic
Dryer filter replacement alarm	Active
Vac. pump oil replace alarm	Active
Full/empty tank check alarm	Active
Full oil container check alarm	Visual
Empty oil container alarm	Visual
Dimension HxWxD	1050x655x850mm
Dry weight	85kg
Power supply frequency	60Hz
Voltage	120VAC, 1 phase
Total max load	7.5A
Overcurrent protection	12A (circuit breaker)
Operating temperature	50-122°F
Humidity	10-90%RH (non condensing)
Storage temperature and hu- midity	-13 to 50°F 10-90%RH (non condensing)
Ambient pressure	75kPa - 106kPa
Max operating altitude	2000m
Pollution degree	2
Water degree	0
Certifications	SAE J2788 UL1963 CAN/CSA STD C22.2 NO. 120-M91

5. Equipment installation

5.1 Unpacking ACX1150



Warning – Risk of personal injury!
Incorrect handling could cause equipment to overturn.



➤ The manufacturer disclaims all responsibility for damage to objects and/or persons resulting from the equipment being wrongly removed from the pallet, or if the operation is performed by unsuitable personnel, with improper means/protections and without complying with the existing laws on manual handling of loads and with the operations described in this manual.

1. Cut the straps and remove carton (Fig 10).



Fig. 10: Removing carton

2. Cut straps securing unit to pallet.

3. With 2 people, lift both front wheels by levering with the handle so unit is setting on the rear wheels (Fig. 11).



Fig. 11: Tilting unit backwards

4. Slowly lower the unit from pallet by means of the rear wheels (Fig. 12).

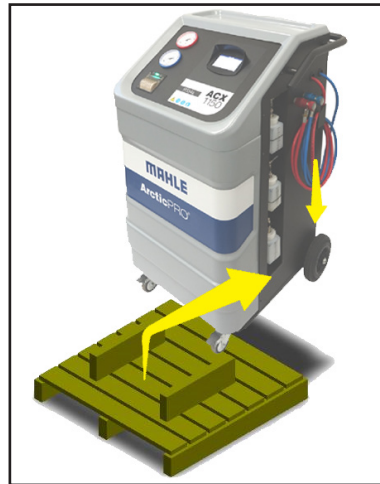

Fig. 12: Lowering unit from pallet

5. Keep the pallet, carton, and scratch protection film for use in case of a need to return unit.

5.2 Load cell screw release

❗ The ACX1150 is shipped from the manufacturing facility with the load cells blocked to prevent damage during shipment.

1. On the underside of the unit (towards the rear), there is a screw with a wingnut threaded into the base. Loosen the wingnut and unscrew bolt (Fig. 13).

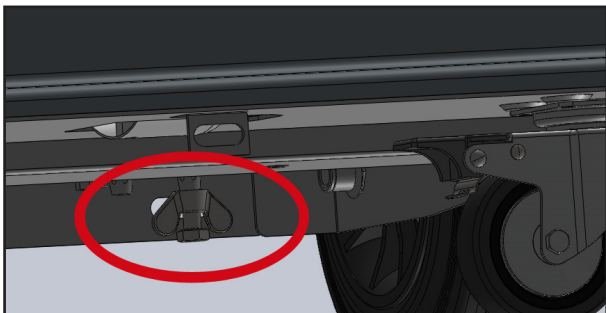

Fig. 13: Removing refrigerant load cell retention bolt

2. On the oil bottle panel, remove the screw circled that is located above the UV dye bottle connection (Fig. 14).

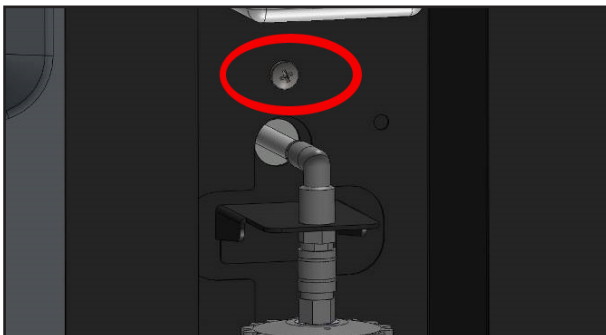

Fig. 14: Removing oil load cell retention screw

6. Commissioning

i All the operations described in Section 5 and 6 must be performed prior to first A/C service.

6.1 Connections and positioning

△ The ACX1150 is designed for 110V, 50/60Hz. Follow the information on the ACX1150 rating plate.

1. Set the ACX1150 on a flat, vibration-proof surface.
2. Actuate the caster brake to stop the ACX1150 from rolling.
3. Connect the power supply cable to the power supply.
4. Switch on the main switch.

△ The unit must be positioned on a stable, horizontal surface to ensure correct operation. Unit must be in an area with proper ventilation and at least 10cm from any potential obstacle to its internal ventilation.

△ Keep unit out of rain and excessive humidity as moisture could cause irreparable damage.

△ Prevent exposure to direct sunlight and excessive dust.

△ Unit must be properly grounded with the power plug ground pin. Failure to ground unit can cause damage and constitutes a risk of fatal injury or shock to the operator.

i Do not unplug any internal electrical connections and only have internal components opened and repaired by trained customer service personnel.

i Contact customer service in the event of any transportation damage (e.g. oil leakage).

i Leave quick couplings closed when unit is not in use and at end of vehicle service operations.

6.2 First start-up verification



Warning – Risk of frostbite from escaping refrigerant

Refrigerant causes severe frostbite on the skin.

- Check the service hoses for damage.
- Firmly connect the service quick-release couplings to the service hoses.
- Wear protective goggles.
- Wear protective gloves.

Execute the following actions in sequential order by following the procedure as shown on the display:

- Gas weight check (vacuums entire refrigerant circuit to ensure no contaminants are in system prior to filling)
- Oil weight check
- First internal cylinder fill

i It is possible to interrupt the initial check and print a report in which the status of the check is reported (if printer option was purchased).

i Equipment cannot operate in automatic mode until all the steps of initial check are completed.

1. Set the internal cylinder fill to desired quantity (min. 3kg).
2. Follow on-screen instructions.
3. Make sure hoses are disconnected from any external source at this time.
4. Start the procedure that initially creates vacuum in the internal refrigerant circuit (approximately 15 minute process).
5. Once message is displayed, the unit can be connected to the external cylinder and the valve opened.
6. Just before the targeted refrigerant amount is reached, unit will pause and prompt user to close external refrigerant tank connection.
7. Once this is done, the unit will continue to recover the refrigerant from the hoses and end once this is completed. The total amount recovered will then be displayed.

- i** Check the type of source tank, two types are available:
- **Refrigerant cylinder with plunger (typically 2 valves):**
Connect to the the liquid valve and keep tank in the upright position to transfer refrigerant.
 - **Refrigerant cylinder without plunger (single valve):**
Connect to the available valve and invert tank to transfer refrigerant.



Fig. 15: Virgin refrigerant cylinder tank types

i The LP (blue) gauge indicates the pressure inside the external cylinder.

6.3 New oil bottle filling (not available on H model units)

- ❗ To fill the new oil bottle (Fig. 1, Pos. 9) it has to be released from the ACX1150 unit. Slightly pull the coupler ring nut downward to remove bottle from fitting.
- ❗ Remove cap from bottle and fill bottle with oil. Replace cap when finished.
- ❗ The valve on the cap contains a silicone polymer membrane that compensates for pressure variations within the bottle and prevents humid air from backfeeding into the bottle and contaminating the oil.

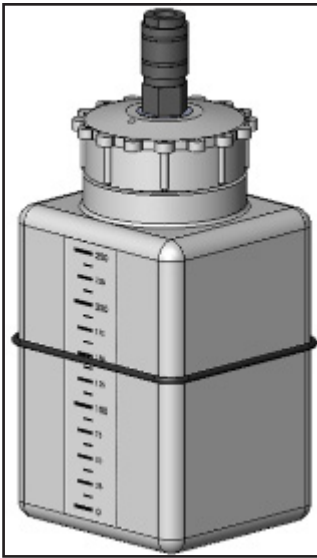

Fig. 16: New oil bottle

6.4 UV dye bottle filling (not available on H model units)

The UV dye is a tracer, a substance made up of a yellow-green colored fluorescent pigment that allows technicians to search for leaks using an ultraviolet lamp.

- ❗ To fill the new oil bottle (Fig. 1, Pos. 7) it has to be released from the ACX1150 unit. Slightly pull the coupler ring nut downward to remove bottle from fitting.
- ❗ Remove cap from bottle and fill bottle with UV dye. Replace cap when finished.
- ❗ The valve on the cap contains a silicone polymer membrane that compensates for pressure variations within the bottle and prevents humid air from backfeeding into the bottle and contaminating the contents.

7. Setup

7.1 ACX1150

❗ From the **SETUP** menu, it is possible to enable/disable and set certain parameters prior to performing A/C system service. To access **SETUP** from the main menu, use the scroll bar or press ▼▲ until **SETUP** can be seen and then use finger to select.

Parameter	Description
EcoLOCK	Enable/disable EcoLOCK functionality
Recharge mode	Select Quick mode or Zero tolerance recharge method
Pressure check	Enable/disable the pressure check
Multipass	Enable/disable the Multipass function
Recovered ref. and oil printing	Enable/disable the displaying and printing of recovered gas quantity.
Report saving mode	Adjust what reports are saved during A/C service mode
Report data	Select data to include in saved and printed report
Unit of measure	Modify the unit of measure for pressure and weight
Clock adjustment	Modify the date and time
Garage data	Enter / modify garage data to be printed on the end of cycle report.
Language	Modify the language displayed on the unit LCD display
Startup screen	Select if upon power-up the unit displays the database page or main menu screen
Default setup	Restore unit default settings

❗ If while adjusting settings user does not want to apply any change made, just press **BACK** button from the specific parameter screen to discard the change made to that specific parameter.

7.1.1 EcoLOCK

1. From the **SETUP** menu, press ▼▲ until **ECOLOCK** is displayed on the LCD. Touch the blue box with finger to select.
2. Select **ENABLE** or **DISABLE** to turn functionality on or off.
3. Press **SAVE** to keep changes or **BACK** to discard changes.

7.1.2 Recharge mode

❗ For a more detailed description of the 2 charge modes, see Section 8.3.

1. From the **SETUP** menu, press ▼▲ until **RECHARGE MODE** is displayed on the LCD. Touch the blue box with finger to select.
2. Select **QUICK MODE** or **ZERO TOLERANCE**. (If Zero Tolerance mode is selected, use ▼▲ to adjust the pressure value.)
3. Press **SAVE** to keep changes or **BACK** to discard changes.

7.1.3 Pressure check

1. From the **SETUP** menu, press ▼▲ until **PRESSURE CHECK** is displayed on the LCD. Touch the blue box with finger to select.
2. Select **ENABLE** or **DISABLE** to turn functionality on or off.
3. Press **SAVE** to keep changes or **BACK** to discard changes.

7.1.4 Multipass

❗ Multipass is a function user can enable that will run when unit is powered up and in an idle state. This function circulates the refrigerant from the internal cylinder through the filters to ensure optimal purity.

1. From the **SETUP** menu, press ▼▲ until **MULTIPASS** is displayed on the LCD. Touch the blue box with finger to select.
2. Select **ENABLE** or **DISABLE** to turn functionality on or off.
3. Press **SAVE** to keep changes or **BACK** to discard changes.

7.1.5 Recovered refrigerant and oil printing

1. From the **SETUP** menu, press ▼▲ until **RECOVERED REFRIGERANT AND OIL PRINTING** is displayed on the LCD. Touch the blue box with finger to select.
2. Select **ENABLE** or **DISABLE** to turn functionality on or off.
3. Press **SAVE** to keep changes or **BACK** to discard changes.

7.1.6 Report saving mode

1. From the **SETUP** menu, press ▼▲ until **REPORT SAVING** is displayed on the LCD. Touch the blue box with finger to select.
2. Select which reports are to be saved by selecting the button for **ALL CYCLES**, **AUTOMATIC CYCLE** or **DISABLED**.
3. Press **SAVE** to keep changes or **BACK** to discard changes.

7.1.7 Report data

1. From the **SETUP** menu, press ▼▲ until **REPORT DATA** is displayed on the LCD. Touch the blue box with finger to select.
2. Select the data to be included on the saved and printed reports. Select the button(s) for **REG NO.**, **KM**, **OWNER** and **TESTER**.
3. Press **SAVE** to keep changes or **BACK** to discard changes.

7.1.8 Unit of measure

1. From the **SETUP** menu, press ▼▲ until **UNIT OF MEASURE** is displayed on the LCD. Touch the blue box with finger to select.
2. Select whether **PRESSURE**, **OIL AMOUNT** or **GAS AMOUNT** units are to be changed by selecting the button.
3. Another screen will appear allowing user to select whether the units are to be shown in **BAR** or **PSI** for pressure, **G** or **ML** for oil amount, or **G** or **OZ** for gas amount.
4. Press **SAVE** to keep changes or **BACK** to discard changes.
5. If other units are to be adjusted, select units to be changed by selecting the button.
6. Press **SAVE** to keep changes or **BACK** to discard changes.

7.1.9 Clock adjustment

1. From the **SETUP** menu, press ▼▲ until **CLOCK ADJUSTMENT** is displayed on the LCD. Touch the blue box with finger to select.
2. Select value that needs to be adjusted.
3. Once value is selected, press ▼▲ until desired value is reached.
4. Press **SAVE** to keep changes or **BACK** to discard changes.

📌 Date is displayed as follows: DD/MM/YYYY.

7.1.10 Garage data

1. From the **SETUP** menu, press ▼▲ until **GARAGE DATA** is displayed on the LCD. Touch the blue box with finger to select.
2. Enter data to be printed on the end of cycle report by selecting the row data is to be entered on.
3. A keyboard will be displayed - enter values and confirm with the enter (↵) key.
4. The screen will automatically change. Once all data is entered, press **SAVE** to keep changes or **BACK** to discard changes.

The screenshot shows a screen titled "Garage data" with five rows of input fields. The first three rows are labeled "ROW 1", "ROW 2", and "ROW 3". The fourth row is labeled "Tel." and the fifth row is labeled "Fax". At the bottom of the screen, there are two buttons: "▲ Back" and "○ Save".

Fig. 17: Garage data screen

Row 1 Company/shop name
 Row 2 Address
 Row 3 City, State and Zipcode
 Row 4 Telephone number
 Row 5 Fax number

7.1.11 Setting language

1. From the **SETUP** menu, press ▼▲ until **LANGUAGE** is displayed on the LCD. Touch the blue box with finger to select.
2. Adjust the language by scrolling through the various options and selecting the desired language.
3. Press **SAVE** to keep changes or **BACK** to discard changes.
4. Unit will restart upon saving the language selection.

⚠️ If a language is selected that is not understood, simply switch unit off, place finger on screen and turn unit back on (while keeping finger on screen). This will automatically load the language selection screen.

7.1.12 Startup screen

1. From the **SETUP** menu, press ▼▲ until **STARTUP SCREEN** is displayed on the LCD. Touch the blue box with finger to select.
2. Select whether the **DATABASE** or **MAIN MENU** screen is the default screen to be displayed upon startup.
3. Press **SAVE** to keep changes or **BACK** to discard changes.

7.1.13 Default setup

1. From the **SETUP** menu, press ▼▲ until **DEFAULT SETUP** is displayed on the LCD. Touch the blue box with finger to select.
2. Press **YES** to reset all settings to the factory settings.

8. A/C service preparation

8.1 Preliminary operations



Warning – Risk of burns from hot engine components

Contact with hot engine components will cause severe burns.



- Allow the engine to cool down.
- Wear protective goggles.
- Wear protective gloves.



Warning – Risk of frostbite from escaping refrigerant

Refrigerant causes severe frostbite on the skin.



- Check the service hoses for damage.
- Firmly connect the service quick-release couplings to the service hoses.
- Wear protective goggles.
- Wear protective gloves.

Perform the following preparatory work prior to vehicle A/C service:

- ⚠ Service hoses must be constructed of the proper materials and have the lengths as supplied with the unit. Hoses must have shutoff devices (quick-release couplers) at the connection point to the A/C to minimize the introduction of air into the ACX1150 and to minimize the amount of refrigerant released while disconnecting the hoses.
 - ⚠ Inspect hoses for signs of damage prior to performing A/C service. Use of damaged hoses will result in the loss of refrigerant and the possibility of refrigerant contamination.
 - ℹ Follow the vehicle manufacturer's recommendations for A/C service on vehicles with a low-pressure connection only.
1. Set the ACX1150 on a flat, vibration-proof surface.
 2. Actuate the caster brake to stop the unit from rolling.
 3. Connect the power supply cable to the power supply.
 4. Switch on the main switch.
- ℹ Follow the manufacturer's instructions for the corresponding vehicle before performing A/C service.

ℹ A/C service operations (especially recovery) should be performed after the vehicle has been run for a period of time to allow engine heat to raise system pressure. This allows for the maximum refrigerant recovery amount to occur. If system is excessively hot, the recharge phase could be adversely effected.

⚠ The ACX1150 is only to be operated with R134a refrigerant. Check which refrigerant is used for the vehicle before performing A/C service.

⚠ The ACX1150 cannot be used for air conditioning systems repaired using a chemical sealant. Non compliance will void the warranty.

⚠ Never attempt to close the valves of the internal refrigerant bottle while the ACX1150 is in operation.

⚠ Only new lubricant, as specified by the system manufacturer, shall be installed in the MAC system. Lubricant removed from the system and/or equipment shall be disposed of in accordance with the applicable federal, state, and local procedures and regulations.

ℹ The service parameters (recharge quantity) can be found in the owner's manual or the vehicle repair manual.

8.2 Non-condensable gas discharge

- ℹ If the ACX1150 detects non-condensable gases in the internal cylinder, the unit will prompt technician to allow unit to run an air purge. This prompt will occur every time unit is powered on (if unit has been powered off for at least 1 hour).
- ℹ The process will perform automatically upon the start of a charge procedure if non-condensibles are detected.
- ℹ Air purge is a necessary process to ensure ideal working parameters for the ACX1150. Presense of non-condensable gases will increase tank pressure and reduce efficiency of recharge cycles.



Fig. 18: Non-condensable gas purge valve
1 Purge solenoid

8.3 Charge modes

i The ACX1150 has 2 different refrigerant charge methods. If charge does not complete using Quick mode, the Zero tolerance method automatically commences. Changing between selections is covered in Section 7.1.2.

8.3.1 Quick mode

i In Quick mode, the ACX1150 injects refrigerant through the HP port. The refrigerant remains in the hoses at the end of the cycle and is then recovered during a hose clearing process.

8.3.2 Zero tolerance mode

⚠ While the Zero tolerance mode is slightly longer in time, it provides a more accurate recharge and guarantees a successful charge.

i In Zero tolerance mode, the ACX1150 will by default charge through the HP (red) hose, then refrigerant that remains in the hoses is pulled into the vehicle's A/C system through the LP (blue) hose.

i In the instance where only a LP coupling is available for A/C service, the ACX1150 will charge the system with 50% of the total charge amount with the vehicle A/C compressor off. The unit then waits 10 minutes to allow the liquid refrigerant to evaporate to prevent damage to the compressor. The vehicle must be started and the A/C system turned on. The ACX1150 will continue to charge refrigerant whenever the LP hose pressure is less than 3 bar.

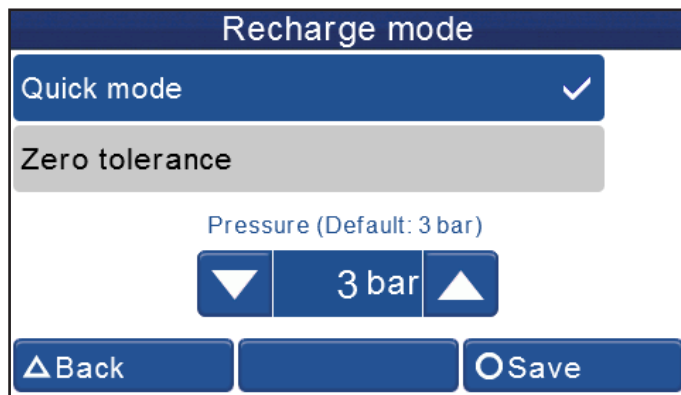

Fig. 19: Charge mode selection

9. A/C system service

9.1 Automatic cycle setup

Access to automatic cycles is available through the main menu by selecting **AUTOMATIC CYCLES**.

- To begin Automatic cycle setup, user is given the option to perform the charge using preloaded values from an A/C database, load the parameters used during the last A/C service or select My database to load custom parameters previously saved by the technician.

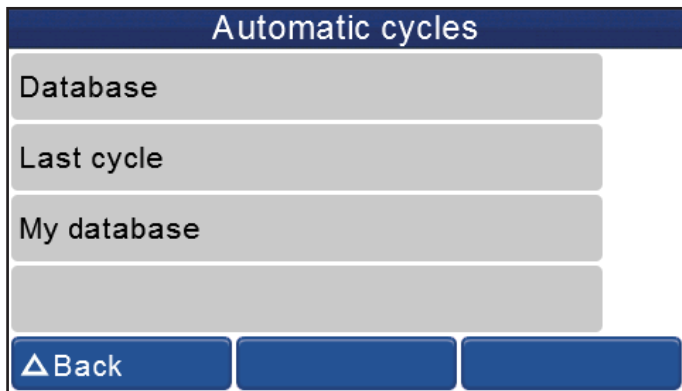

Fig. 20: Automatic cycle selection

9.1.1 Database

MAHLE offers customers that purchase the ACX1150 the possibility to enhance the functionality of the unit through the database.

- The database contains all data related to the A/C system of most vehicles, which makes it possible to speed up the setup of A/C service.

If the **DATABASE** option is selected, parameter selection is as follows:

- Make
- Model
- Version / engine size
- Year
- System options

After the selection is made, a screen will appear showing the data for the process (Fig. 21).

9.1.2 Last cycle

If the **LAST CYCLE** option is selected, the ACX1150 loads the parameters used during the last Automatic cycle. These parameters can be modified in the screen that follows if necessary.

9.1.3 My database

If **MY DATABASE** is selected, the ACX1150 allows the technician to select one of the (up to 100) saved custom charge cycles saved in the unit.

- The user must set these cycles up and save them for them to be selectable during Automatic process.

9.2 Automatic cycle

After selecting how the technician would like to load the A/C service data, the screen in Fig. 21 will appear.

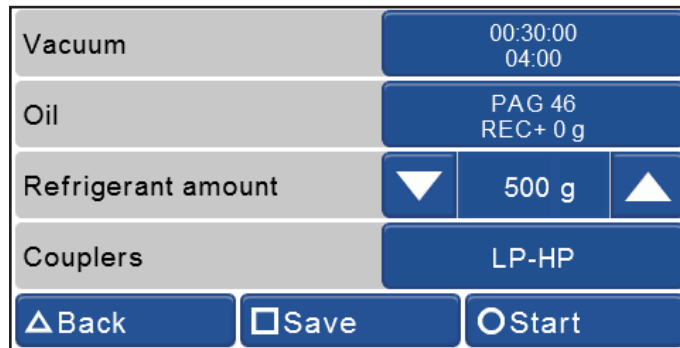

Fig. 21: Parameter adjustment

9.2.1 Vacuum

- The top row displays the vacuum time. To adjust the vacuum time, touch the blue box at the right hand side of the screen. Adjust vacuum time by using the ▼▲ on the next screen (Fig. 22). Adjust vacuum test time using the same method. Press the **OK** button at the bottom right of the screen to save selection or press the **BACK** button to discard changes and go back to the screen in Fig. 21. Adjusted vacuum time should appear in the top row.

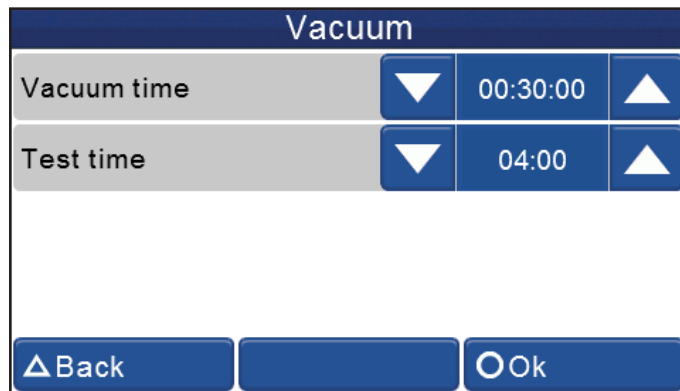

Fig. 22: Vacuum setup screen

9.2.2 Oil

- The amount of oil to be charged and the type of oil should be displayed on the second line. To adjust the oil type or quantity to be charged, touch the blue box at the right hand side of the screen. When the next screen appears (Fig. 23), adjust parameters (details below). Press the **OK** button at the bottom of the screen to save selection or press the **BACK** button to discard changes and return to previous screen. This function is not available on ACX1150H model units.

Oil mode: Select which mode to use for oil charge.

- OIL: Unit injects the oil amount that has been set.
- REC. +: Unit injects the quantity of oil recovered from the vehicle A/C system plus the oil amount that has been set by technician.
- NO OIL: No oil is injected during the injection cycle.

Oil amount: Adjust oil quantity to charge.

- Press ▼▲ to adjust oil amount to be charged.

Oil type: Select oil type

- PAG 46, PAG 100, PAG 150
- POE

Tracer: Select if UV (tracer) dye is to be injected during cycle.

- If YES is selected, a single shot (approx. 8g) of UV (tracer) dye will be injected.

Fig. 23: Oil charge adjustment

9.2.3 Refrigerant

- i** The amount of refrigerant to be charged into the system is listed on the third line of the screen. To adjust the charge amount, press ▼▲ to increase/decrease the value.

Fig. 24: Refrigerant charge adjustment

9.2.4 Couplers

- i** The last row displays the hose selection for the service. To adjust the hose selection, touch the blue box at the right hand side of the screen. The following options are available:
- HP only
 - LP only
 - LP - HP
 - HP(LP) - Injection through HP hose on the system low pressure side (Specific for some Renault models).

Fig. 25: Service coupler selection

- ➔ After the parameters are adjusted, press **START** to begin the Automatic cycle or press **SAVE** to save the cycle information with a name in the My Database record.

9.2.5 Electric compressor function (ACX1150H only)

1. Before connecting to A/C system, a screen will then appear to adjust the vehicle's compressor type (Fig. 26).

Fig. 26: Compressor type selection

2. If the selected type is Electric (high voltage), a special flushing procedure will be executed to clear any potential oil residue in hoses from previous services. The screen in Fig. 27 will appear and the hoses should be connected as illustrated in Fig. 28.

Fig. 27: Electric compressor function



Fig. 28: Flush adapter connection

3. After the connection is made, select and confirm YES to proceed and follow instructions displayed on screen.

9.3 Manual cycles

i Access to manual cycles is available through the main menu by selecting **MANUAL CYCLES**.

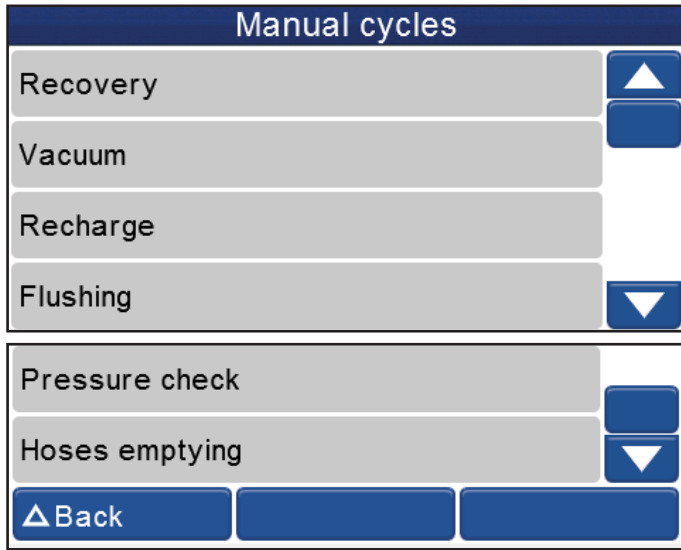

Fig. 29: Manual mode screen options

9.3.1 Recovery process

1. In the manual cycle menu, select **RECOVERY**.
2. Follow on screen instructions to begin recovery process.

i If no pressure is detected in the system, this function will not start. Technician should ensure couplers are open. If the system is empty, operator must exit and select a vacuum process.

⚠ There is potential for unit to display an error during this service for high internal pressure. This can occur due to high operating temperatures or hot refrigerant gasses entering the ACX1150.

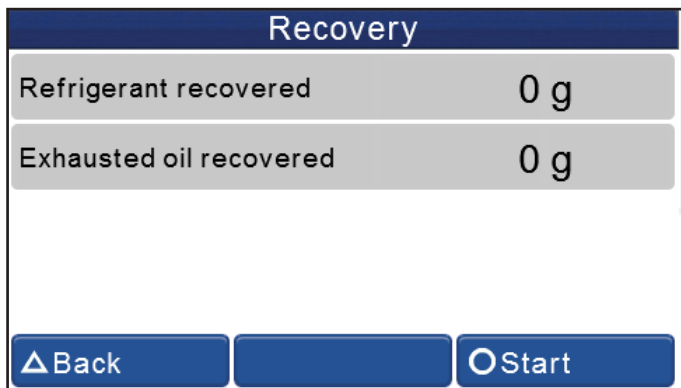

Fig. 30: Recovery screen

9.3.2 Vacuum process

1. In the manual cycle menu, select **VACUUM**.
2. The unit will display a screen for technician to adjust the length of vacuum time and vacuum test time. Use the **▼▲** to adjust the cycle times.
3. Connect HP/LP coupler(s) to the vehicle A/C system, open the couplers and select **START**.

i Be sure recovery has been performed prior to running a vacuum cycle.

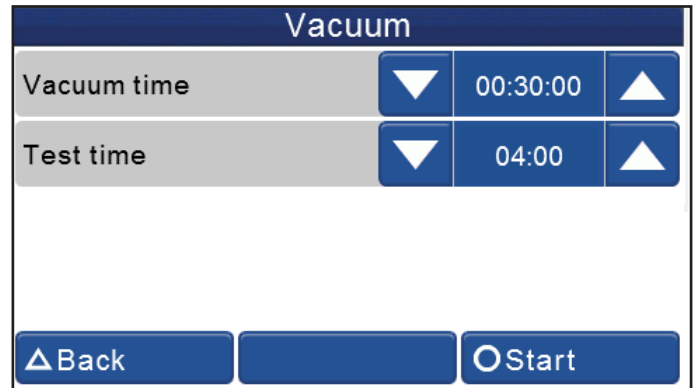

Fig. 31: Vacuum setup screen

i Vacuum time can be adjusted to any value between 4 minutes and 18 hours in 1 minute increments.

i Vacuum test time can be adjusted to any value between 0 and 30 minutes in 30 second increments.

9.3.3 Recharge

1. In the manual cycle menu, select **RECHARGE**.
2. Adjust the settings for The **OIL**, **REFRIGERANT AMOUNT**, and **COUPLERS** as described in the sections below.

Recharge		
Oil	PAG 100 0 g	
Refrigerant amount	▼	750 g ▲
Couplers	LP-HP	
<div style="display: flex; justify-content: space-between; margin-top: 10px;"> ▲ Back ○ Start </div>		

Fig. 32: Manual recharge setup screen

Oil (not applicable to ACX1150H model units)

- ❗ The amount of oil to be charged and the type of oil will be displayed. To adjust the oil type or quantity to be charged, touch the blue box at the right hand side of the screen. When the next screen appears (Fig. 33), adjust parameters (details below). Press the **OK** button at the bottom of the screen to save selection or press the **BACK** button to discard changes and return to previous screen. This function is not available on ACX1150H model units.

Oil amount: Adjust oil quantity to charge.

- Press ▼▲ to adjust oil amount to be charged.

Oil type: Select oil type

- PAG 46, PAG 100, PAG 150
- POE

Tracer: Select if UV (tracer) dye is to be injected during cycle.

- If YES is selected, a single shot (approx. 8g) of UV (tracer) dye will be injected.
- If POE oil is the oil type, UV (tracer) dye injection is not available.

Oil		
Oil amount	▼	0 g ▲
Oil type	PAG 100	
Tracer	No	
<div style="display: flex; justify-content: space-between; margin-top: 10px;"> ▲ Back ○ Ok </div>		

Fig. 33: Oil charge adjustment

Refrigerant

- ❗ The amount of refrigerant to be charged into the system is listed on the third line of the screen. To adjust the charge amount, press ▼▲ to increase/decrease the value.

Refrigerant amount	▼	620 g	▲
--------------------	---	-------	---

Fig. 34: Refrigerant charge adjustment

Couplers

- ❗ The last row displays the hose selection for the service. To adjust the hose selection, touch the blue box at the right hand side of the screen. The following options are available:

- HP only
- LP only
- LP - HP
- HP(LP) - Injection through HP hose on the system low pressure side (Specific for some Renault models).

Couplers	LP-HP
----------	-------

Fig. 35: Service coupler selection).

3. Connect couplers to the vehicle fittings and press **START**.
4. Follow on-screen instructions to complete service.

9.3.4 Flushing (with optional accessories)

- ❗ After replacing components or parts of the A/C system, it is advisable to carry out a system flush procedure.

- ❗ The system flush process charges liquid refrigerant through the connected components and filters impurities through an additional filter.

1. Install flushing kit as described in the instructions included with kit.
2. In the manual cycle menu, select **FLUSHING**.
3. Follow on-screen instructions.

Flushing	
Vacuum time	00:00:04
Refrigerant weight	0 g
Vacuum	
<div style="width: 50%; height: 10px; background-color: #0070C0; margin: 0 auto;"></div>	
<div style="display: flex; justify-content: space-between; margin-top: 10px;"> ▲ Abort </div>	

Fig. 36: Flushing screen

9.3.5 Pressure check

i This process is used as a means to diagnose A/C system issues by checking the pressure inside the vehicle's A/C system using the ACX1150.

1. Connect HP & LP couplers to the vehicle A/C system.
2. Follow on-screen instructions - start vehicle and turn on the A/C system.
3. Set temperature at coldest setting.
4. Set fan speed at maximum level and close all vents except the central one and set air distribution to that vent.
5. Keep engine at a high idle speed (approx. 2000RPM) for at least 2 minutes.
6. Check pressure values in 3-5 minutes.
7. In the manual cycle menu, scroll until **PRESSURE CHECK** is visible on screen and select it.
8. Follow the automatic procedure.
9. Check that both values on the HP and LP gauges fall between the values shown on the display.

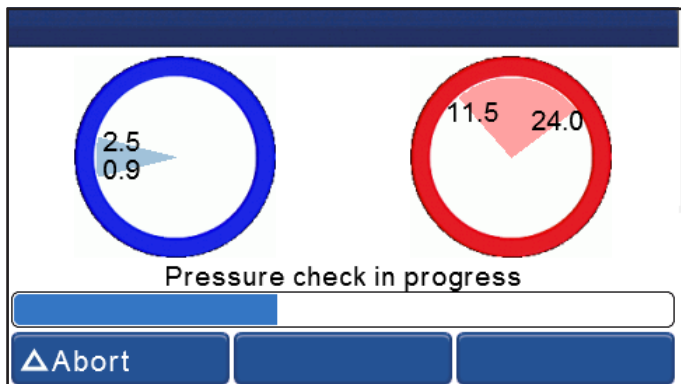

Fig. 37: Pressure check screen

⚠ Pressure values change considerably when ambient temperature changes. Keep this in mind when checking pressure values.

9.3.6 Hose emptying

1. To clear pressure from inside unit hoses, in the manual cycle menu, scroll until **HOSE EMPTYING** is visible on screen and select it.
2. Allow procedure to run to completion.

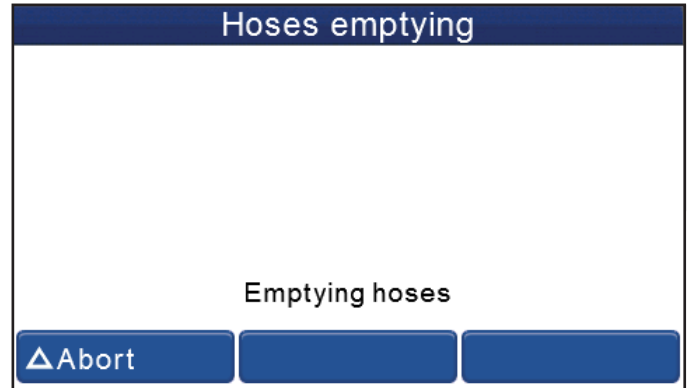

Fig. 38: Hose emptying screen

10. Maintenance

- ❗ Please contact an authorized technical service center for purchasing factory replacement parts.

10.1 Maintenance interval and overview

Description	Period
Calibration of scales	1x per year to ensure accuracy
Vacuum pump oil replacement and system leak test	After 1000 hours of service
Combo filter replacement and system leak test	After 75kg of refrigerant processed
System leak test	As required

⚠ Make sure ACX1150 is disconnected from power before removing plastic housing.

⚠ Never perform any maintenance work which is not expressly recommended in this section.

⚠ Contact customer service if components have to be replaced other than in the course of maintenance work.

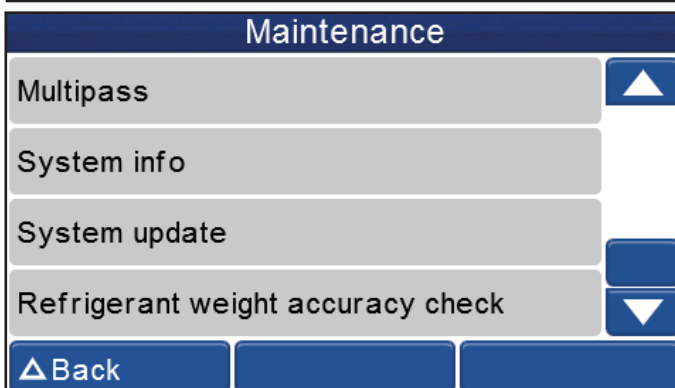
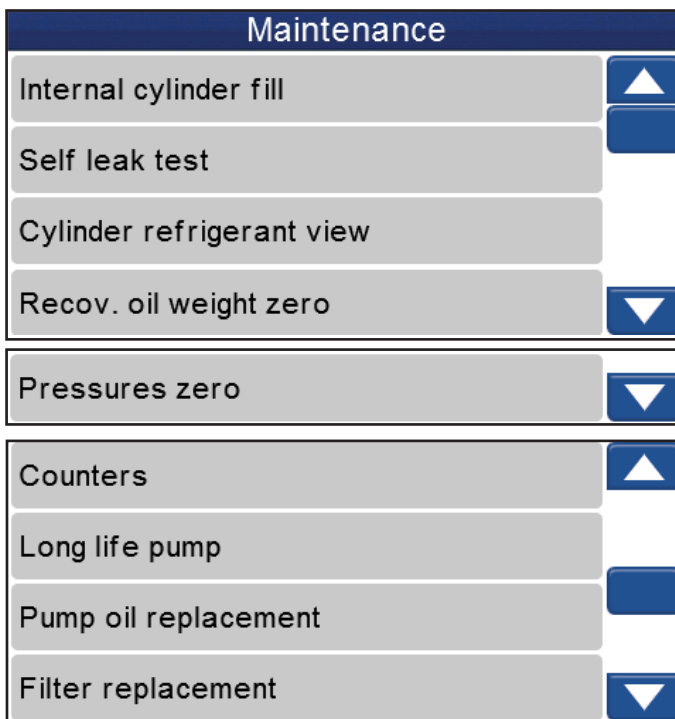

Fig. 39: Maintenance screens

10.2 Filling internal refrigerant cylinder



Warning – Risk of frostbite from escaping refrigerant

Refrigerant causes severe frostbite on the skin.



- Check the service hoses for damage.
- Firmly connect the service quick-release couplings to the service hoses.



- Wear protective goggles.
- Wear protective gloves.

- ❗ Before the ACX1150 can be used, the internal refrigerant cylinder must be filled with liquid refrigerant. Use only R134a refrigerant.

- ❗ The refrigerant can be obtained from your gas supplier. It can be stored normally and transported in bottles with connection fittings.

- ❗ To ensure a reliable procedure, it is advisable to use the optimum quantity of refrigerant. The optimum quantity of refrigerant for the ACX1150 is 4kg – 10kg.

- ❗ An inadequate quantity may make efficient filling of the vehicle air conditioning system impossible. Also, if there is an insufficient quantity, the ACX1150 may not be able to operate efficiently. In the event of an excessive quantity, there may not be sufficient space for the refrigerant recovered from the vehicle air conditioning system.

⚠ Do not open coupler until unit prompts technician to open.

1. In the maintenance menu, select **INTERNAL CYLINDER FILL**.
2. Use ▼▲ to set desired amount of refrigerant to pull into ACX1150 unit.
3. Press **START**.
4. Follow the menu prompting.

- ❗ The current pressure inside the external refrigerant bottle is indicated on the low-pressure gauge.

⚠ Do not interrupt the automatic filling process prior to automatic termination by the ACX1150.

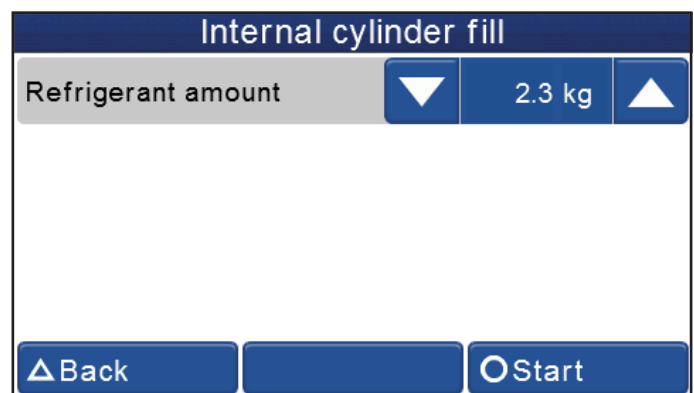

Fig. 40: Internal cylinder fill setup screen

10.3 Self leak test

i This test is designed to check the internal ACX1150 circuit for any leaks. The test checks through various solenoids, the manifold, compressor, and assorted filters.

To perform Self leak test:

1. In the maintenance menu, scroll until **SELF LEAK TEST** is visible on screen and select.
2. Ensure unit is disconnected from any system and press **YES**.
3. Allow unit to perform test to completion.

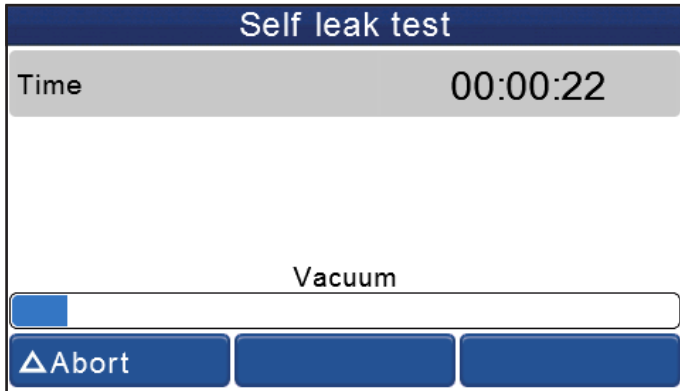

Fig. 41: Self leak test screen

i If a test fails, check charge hoses and quick couplers for leak first. If repair is possible, fix the leak and repeat test.

10.4 Cylinder refrigerant view

1. In the maintenance menu, scroll until **CYLINDER REFRIGERANT VIEW** is visible on screen and select.
2. Screen will display the Total refrigerant weight and the Available refrigerant weight.

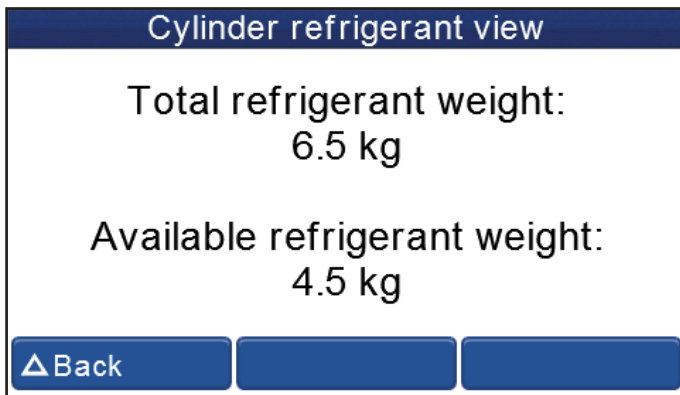

Fig. 42: Refrigerant weight screen

i Available refrigerant weight is 2kg less than total contents of cylinder. 2kg is the minimum quantity that should be left in an operating ACX1150.

10.5 Recovered oil weight zero (tare)

⚠ This procedure can only be implemented on **ACX1150H model units**. The standard ACX1150 will not have this functionality built in.

1. In the maintenance menu, scroll until **RECOVERED OIL WEIGHT ZERO** is visible on screen and select.
2. If bottle is empty, the weight should be $0 \pm 5g$. If reading is excessively high or low, press **RESET** button.

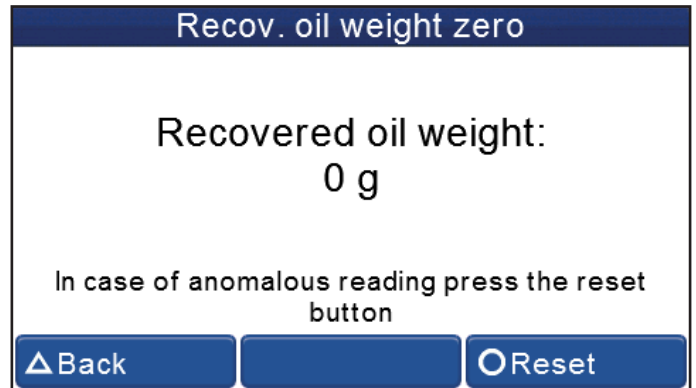

Fig. 43: Recovered oil weight tare

3. Screen in Fig. 44 will appear to remind user to empty the oil bottle. Once bottle is empty and reconnected to unit, press **YES**.

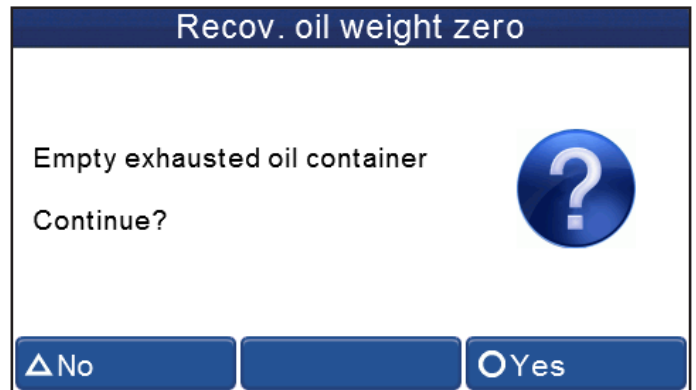

Fig. 44: Empty oil container

4. Process will reset the zero point of the recovered oil scale and return to the screen shown in Fig. 43.

10.6 Pressure zero

i This function allows technician to determine and store the atmospheric pressure value.

1. In the maintenance menu, scroll until **PRESSURE ZERO** is visible on screen and select.
2. Follow on-screen instructions to complete process.

△ This procedure should be performed every time the ACX1150 is moved from one location to another that has a different altitude.

10.7 Counters

i These screens will display the vacuum pump and compressor hours of life and the remaining time before vacuum pump oil and the filter dryer need replacement.

1. In the maintenance menu, scroll until **COUNTERS** is visible on screen and select.
2. Press **BACK** to exit.

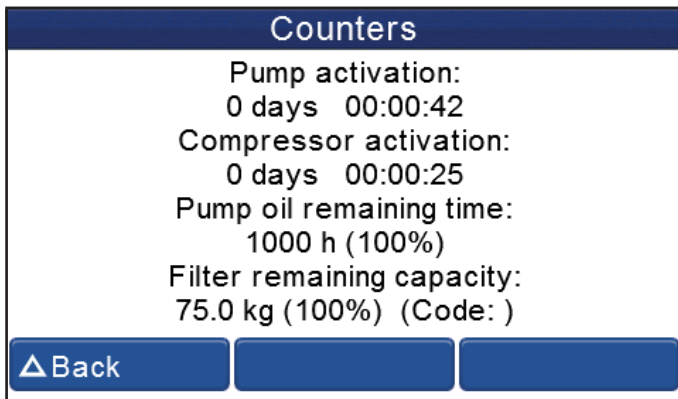

Fig. 45: Counters

10.8 Long life pump test

i The Long Life Pump function equipped on the ACX1150 enables the unit to optimize the vacuum pump oil use and avoid the need to replace after every 60 hours of operation.

1. After the first 60 hours of vacuum pump operation, check the vacuum pump oil level and top-off if necessary.
2. In the maintenance menu, scroll until **LONG LIFE PUMP** is visible on screen and select.
3. Press **START** to begin long life pump test or press **BACK** to exit.
4. The process will run for approximately 1 hour.

i During this process, the vacuum pump oil is automatically purified from the gaseous residues absorbed by the oil during the vacuuming of vehicle A/C systems.

5. At end of procedure, vacuum pump performance check is executed and the result is displayed on the display.

i If the result of the Long Life Pump test is negative, the oil must be changed.

i If the results pass, the pump oil remaining time will change to 1000 hours. After 1000 hours of runtime, the oil must be changed.

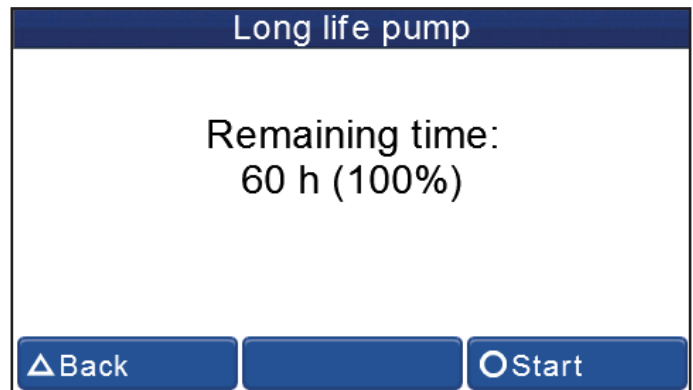

Fig. 46: Long life pump screen

10.9 Vacuum pump oil change

i After 60 hours of runtime (or 1000 hours if the Long Life Pump test is completed successfully), the vacuum pump oil must be replaced.

1. Disconnect ACX1150 from power.
2. Remove the six screws that affix front panel to the ACX1150 using a 2.5mm Allen key.

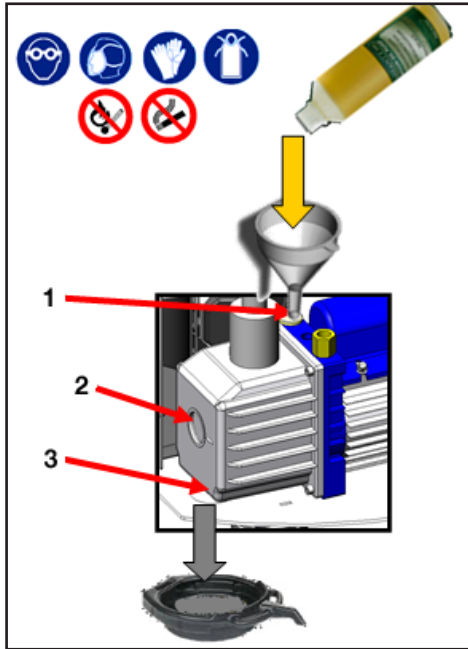

Fig. 47: Changing vacuum pump oil

- 1 Oil filling plug
- 2 Oil inspection window
- 3 Lower drain plug

3. Place a bowl under the vacuum pump oil drain hole. Remove the upper filling plug and the lower drain plug to allow the oil to drain from unit.
4. Once the pump has been emptied, reinstall the lower drain plug.

5. Fill the pump with new oil through the upper fill port using a funnel if needed. Fill until the oil appears halfway up the oil level inspection window.
6. Once the pump has been filled, reinstall the upper fill plug.
7. Reinstall front panel and power on unit.
8. Under maintenance, scroll until **PUMP OIL REPLACEMENT** is visible on screen and select. Press the **RESET** key to set the counter.

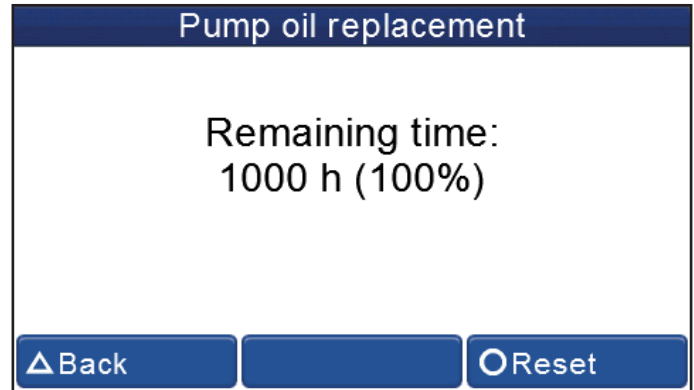

Fig. 48: Reset vacuum pump oil life

i The level and clearness of the vacuum pump oil can be checked by removing the rubber plug located on the front-left side of the unit.

10.10 Replace filter dryer



Warning – Risk of frostbite from escaping refrigerant

Refrigerant causes severe frostbite on the skin.



- Check the service hoses for damage.
- Firmly connect the service quick-release couplings to the service hoses.



- Wear protective goggles.
- Wear protective gloves.

- ❗ Unit operation is disabled at the end of the filter service life. Each filter is marked with a unique code. This code must be entered when replacing the filter. It is not possible to operate the ACX1150 if the same code is re-used. It is advisable to keep a supply of filters in stock to avoid downtimes due to the unit being disabled.
- ❗ The ACX1150 is disabled once 75kg of R134a refrigerant has passed through the filter. A new filter must be installed and its unique code entered in the ACX1150 before vehicle A/C service can be performed.

1. To begin the filter replacement process, under maintenance, scroll until **FILTER REPLACEMENT** is visible on screen and select.
2. Press **START** to begin filter replacement process.

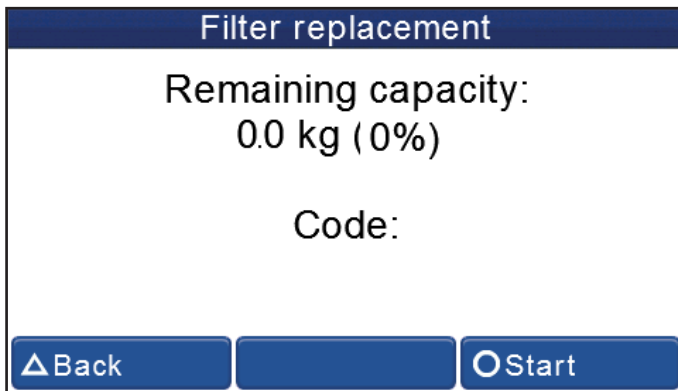

Fig. 49: Filter replacement

3. Insert the new filter code using the on-screen keyboard (Fig 50).
4. Press enter (↵) to complete code entry.

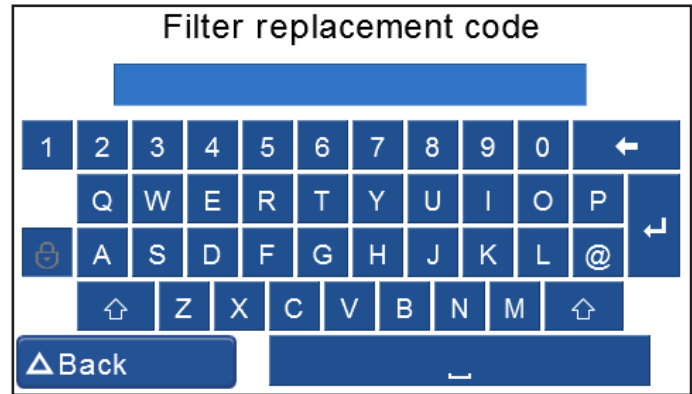

Fig. 50: Filter code entry

5. Disconnect the HP and LP couplers and hoses from any external connection and allow the hose drain process to run to completion.
6. Disconnect ACX1150 from power supply.
7. Remove the six screws that affix front panel to the ACX1150 using a 2.5mm Allen key.
8. Unscrew the 2 connection nuts from top and bottom of the filter using a 17mm open-ended wrench to prevent the filter from spinning and a 24mm open-ended wrench to loosen the nuts.
9. Remove the straps that hold filter in place.
10. Install new filter paying attention to the position of the gaskets and ensure arrow faces downward.

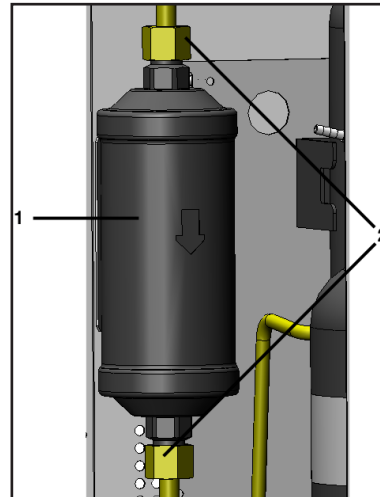

Fig. 51: Replacing filter

- 1 Filter dryer
- 2 Connection nuts

11. Tighten the 2 connection nuts to the filter.
12. Reinstall front panel.
13. Connect unit to power and turn on.
14. Allow unit to perform the automatic leak test requested by the software when unit loads.

⚠ Take care not to damage any hoses or electrical connections when changing the filter.

⚠ Never re-use an old filter.

10.11 Multipass

- i** Run this procedure to circulate refrigerant within the ACX1150. This allows the unit to further purify the refrigerant and remove any dirt / other impurities.
1. Under maintenance, scroll until **MULTIPASS** is visible on screen and select.
 2. Press **START** to begin process.

10.12 System info

- i** In the System info page, the software version and serial number can be displayed.
1. Under maintenance, scroll until **SYSTEM INFO** is visible on screen and select.
 2. Press OK to return to **MAINTENANCE**.

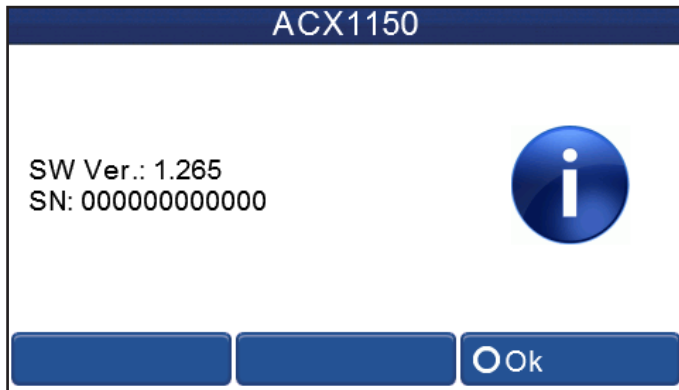

Fig. 52: System information screen

10.13 Software update

- i** The firmware (software) can be updated by way of a USB stick.
1. Insert USB stick in USB port (Fig. 3 Pos. 4).
 2. Power on ACX1150.
 3. Under maintenance, scroll until **SOFTWARE UPDATE** is visible on screen and select.
 4. A message will appear that the unit is loading an update.
 5. The unit may load an updated language file and configuration file while updating.
 6. Once unit is updated, the software version string on the introduction screen during power up will change.

10.14 Refrigerant weight accuracy check

i An automatic procedure is built in to the system that allows the technician to check the accuracy of the refrigerant weight scale.

⚠ Before removing the front panel of the ACX1150, turn unit off and disconnect power cord.

1. Remove the six screws that affix front panel to the ACX1150 using a 2.5mm Allen key.
2. Unscrew the bolt and wingnut that hold the reference weight to the base panel of the equipment.



Fig. 53: Reference weight location

1 Reference weight

3. Connect the power cord to power supply and switch on unit.
4. Under maintenance, scroll until **REFRIGERANT WEIGHT ACCURACY CHECK** is visible on screen and select. .
5. Press **YES** to continue when the screen in Fig. 54 appears.

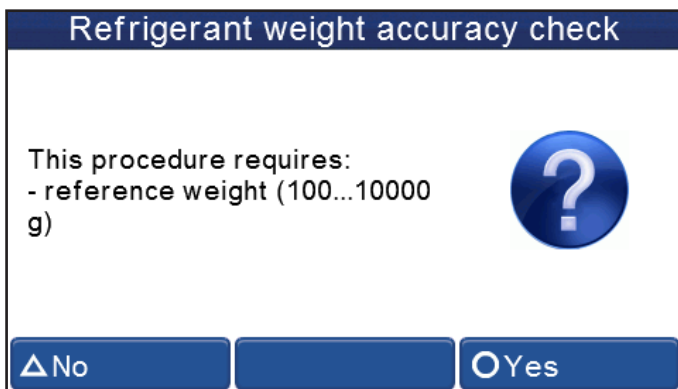

Fig. 54: Refrigerant weight check screens

6. Follow the instructions on the screen and when the screen in Fig. 55 is displayed, place the reference weight below the tank over the two screws of the load cell and press **YES**.

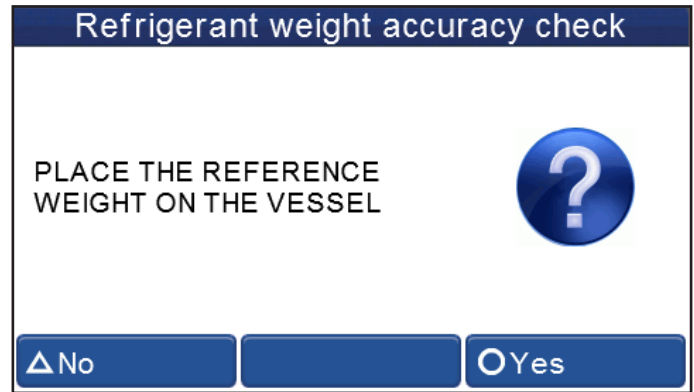

Fig. 55: Place weight screen

7. Type the weight of the reference weight in the screen below and press **YES**.

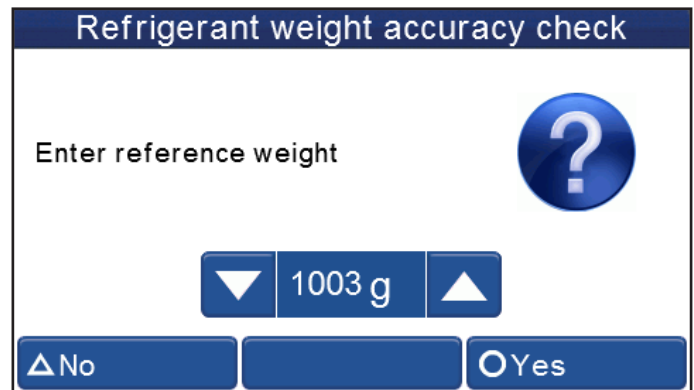

Fig. 56: Weight entry screen

- i** The mass of the reference weight should be identified on a side of the weight.
8. Allow unit to perform the check of the load cell calibration.
9. After the check is complete, a pass or fail result will be displayed.
10. Switch off unit and disconnect power cord.
11. Return reference weight to its position on the base panel of the ACX1150 and reinstall front plastic.

⚠ In the case of a failure during the Refrigerant weight accuracy check, perform the test a second time for verification. If the resulting test is a second failure, a calibration of the internal refrigerant weight scale should be performed.

10.15 Printer maintenance

1. Open the lid of the printer as shown in Fig. 57.

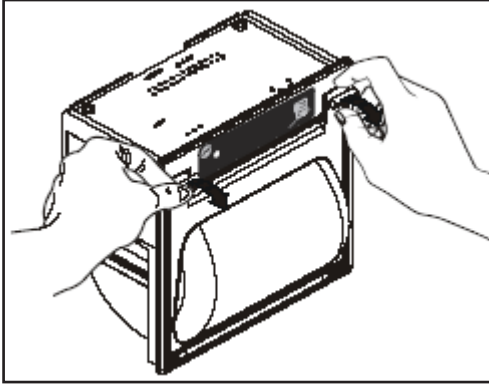

Fig. 57: Opening printer

2. Position the roll of paper inside the housing in the rotation direction indicated in Fig. 58.

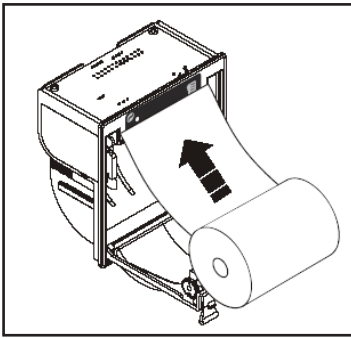

Fig. 58: Installing new paper roll

3. Pull the paper out of the housing as shown in Fig. 59 and close the lid.

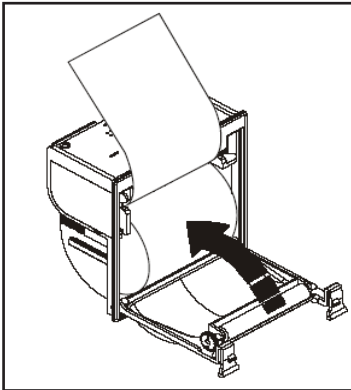

Fig. 59: Completing installation

4. The printer is ready for printing.

10.16 Periodic checks

ⓘ The ACX1150 service station must be checked over regularly as set by local legislation.

⚠ The following checks should be performed to ensure safe and reliable operation:

- Make sure no corrosion or leakage is present in the internal cylinder and other metallic parts of the equipment (under normal conditions the internal cylinder life is at least 20 years).
- If automatic safety valve trips, contact technical support to have unit inspected, resolve any issues and replace valve if necessary.
- If the safety pressure switch trips, check the connection of the cables and correct connection to the PCB. Contact technical support for additional assistance.
- Check that external charging hoses - both red (HP) and blue (LP) - are in good order and undamaged. In the case of damaged hoses, discontinue use of ACX1150 until replacement hoses are procured.
- Verify that vacuum pump oil and filter dryer have been replaced according to schedule for proper functioning equipment.

11. Spare parts

Description	Order number
Combo filter	026 80696 00
Vacuum pump oil	011 80070 00
Paper for printer (5 rolls)	360 83110 00
Service hose (HP)	028 80532 00
Service hose (LP)	028 80533 00
Quick-release coupling (HP)	023 80463 00
Quick-release coupling (LP)	023 80464 00
Used oil bottle	026 80699 00
Safety goggles (accessory item)	360 82956 00
Protective gloves (accessory item)	360 82957 00
Dust cover (accessory item)	026 80697 00
Adapter LP (external bottle), US ACME 1/2	023 80147 00
Adapter HP (external bottle)	023 80465 00

i Additional spare/replacement parts are available through the service centers authorized by MAHLE or by its reseller. Contact technical support for replacement parts not listed above.

12. Disposal

12.1 A/C Service unit disposal

At the end of its service life, this equipment must be disposed of as follows:

- Contact the service center to have the refrigerant in the unit recovered and recycled.
- Consign the unit to an authorized collection center according to local legislation.

12.2 Recycled material disposal

- Return the refrigerant recovered from the unit to the refrigerant supplier for proper disposal or recycling.
- Lubricants extracted from the vehicle's A/C system must be returned to an official oil collection center.

12.3 Packaging disposal

⚠ Electronic and electrical A/C service equipment must never be disposed of with domestic waste, but recycled appropriately.

- The packaging must be disposed of in conformity with local legislation.
- This contributes to protecting the environment.

13. Troubleshooting

i Please contact technical service if any of the actions suggested in this section cannot be implemented.

i Notice/Warning codes are coded **Wxxx** on the title of the window.

i Alarm codes are coded **Axxx** on the title of the window - alarms terminate procedure and prevent its resumption.

13.1 ACX1150

Error code	Messages	When it occurs	Possible solutions	Action
W008	REPLACE VACUUM PUMP OIL	- When required after Pump Monitoring system procedure	- Pump oil contaminated	- Replace pump oil
W009	REPLACE DRYER FILTER	- Every year since installation	- Filter capacity is finished	- Replace dryer filter
W025	REFRIGERANT QUANTITY TOO HIGH	- During the programming of the inner tank charge amount	- Amount required greater than that available in internal tank	- Decrease the set quantity.
W026	RECHARGE CYLINDER EMPTY OR DISCONNECTED	- During the tank filling phase	- Recharging tank empty - Hoses/couplings are clogged/ closed	- Check tank, hoses, taps.
W029	CYLINDER NEARLY FULL	- During the refrigerant recovery or hoses emptying phase.	- Tank close to maximum capacity	- Decrease quantity of gas by filling (injecting) an external suitable tank (with safety valve)
W032	NO PRESSURE - VEHICLE WITHOUT REFRIGERANT OR DISCONNECTED	- During the refrigerant recovery phase	- Hoses not connected - Couplers not opened	- Check connections and leaks in A/C system
W036	FURTHER OIL INJECTION NOT POSSIBLE	- During oil injection phase	- Insufficient vacuum level - Leak in system	- Increase vacuum phase duration - Fix leak in system to hold vacuum
W044	CYLINDER EMPTY	- During flushing or Tank refrigerant internal recycling phase	- Gas level is too low for the procedure to be completed	- Fill the internal tank with gas
W045	LP VERY LOW, CHECK CIRCUIT BEFORE CONTINUING	- During flushing phase	- LP hose disconnected - Flushing couplings not properly connected - Leak in circuit being flushed.	- Reconnect LP and/or the fittings and eliminate any leaks.
W047	POSSIBLE LEAKAGE	- During the refrigerant recovery phase	- Vehicle A/C system may have leaks	- Inspect vehicle A/C system and repair
A000	EEPROM NOT WORKING	- Electronics fault	- EEPROM damaged	- Replace the logic electronic board
A001	EEPROM DATA CORRUPT	- Electronics fault	- EEPROM damaged	- Replace the logic electronic board
A002	PRESSURE SAFETY SWITCH ACTIVATED	- Pressure above 18 bar	- High pressure in the internal tank - Circuit between compressor and tank obstructed or closed	Verify: - If internal CYLINDER pressure level is over 18 bar, wait for pressure reduction, disconnect equipment from the mains, use safety protection - Open equipment and verify if the valve between compressor and internal CYLINDER are open
A003	ADC NOT WORKING	- Electronics fault	- ADC analog-digital converter damaged	- Replace the logic electronic board

Error code	Messages	When it occurs	Possible solutions	Action
A032	CIRCUIT STILL UNDER PRESSURE	– During the vacuum, cylinder filling or leak test phase in vacuum	– The vehicle A/C system is pressurized	– Recover the refrigerant gas from the vehicle before starting another vacuum phase.
A033	CIRCUIT LEAKAGE	– During the vacuum, cylinder filling or leak test phase, both under pressure and in vacuum	– Leakage in the circuit – Leakage in vehicle fittings	– Identify the leak position in the vehicle or connected system and have it repaired by trained and qualified staff according to local legislation.
A034	VACUUM LEVEL TOO LOW	– During tracer injection and oil injection phase. The necessary vacuum level has not been reached.	– Vehicle A/C system is pressurized notwithstanding the vacuum phase – Possible presence of leak(s) inside A/C system – Vacuum phase time not sufficient or phase not executed (manual cycle).	– Repeat cycle, increase vacuum time – If leaks has been identified, identify the leak position in the vehicle or connected system and have it repaired by trained and qualified staff according to local legislation.
A035	CYLINDER EMPTY	– During the gas injection and flushing phase	– Refrigerant gas is too low for the procedure to be completed – Refrigerant load cell out of calibration	– Fill the internal tank – Check calibration and calibrate if necessary
A036	CYLINDER REFRIGERANT QUANTITY TOO LOW	– During the gas injection and flushing phase	– Gas amount in internal tank less than required – Refrigerant load cell out of calibration	– Fill the internal tank – Check calibration and calibrate if necessary
A037	FURTHER REFRIGERANT INJECTION NOT POSSIBLE	– During gas injection phase	– Hoses not connected to vehicle A/C system – Couplers closed – Vacuum not sufficient – Presence of pressure in the circuit	– Caution: before proceeding, empty out the hoses – Repeat the recovery procedure and increase the vacuum phase duration
A038	CIRCUIT LEAKAGE OR DISCONNECTED	– During flushing phase	– Leakages or obstructions in the circuit to be flushed	– Check the connection to the A/C system – Identify the leak in the circuit and have it repaired by trained and qualified staff according to local legislation.
A039	FURTHER OIL INJECTION NOT POSSIBLE	– During oil injection phase	– Insufficient vacuum level – Leak in system	– Increase vacuum phase duration – Fix leak in system to hold vacuum
A043	CYLINDER FULL	– During gas recovery phase – During hose emptying phase	– Internal tank full (maximum capacity level reached)	– Decrease quantity of gas by filling (injecting) an external suitable tank (with safety valve)
A047	LP LEAKAGE	– At the end of the gas injection or, – In the Eco-Lock Lock patented technology quick couplers disconnection phase, or – During the vehicle fittings leak test	– Vehicle A/C system may have leaks at the LP port	– Empty the vehicle (follow the procedure guided by the displayed messages) – Replace LP port/schrader valve inside LP port
A048	HP LEAKAGE	– At the end of the gas injection or, – In the Eco-Lock Lock patented technology quick couplers disconnection phase, or – During the vehicle fittings leak test	– Vehicle A/C system may have leaks at the HP port	– Empty the vehicle (follow the procedure guided by the displayed messages) – Replace HP port/valve inside HP port
A049	LP AND/OR HP LEAKAGE	– At the end of the gas injection or, – In the Eco-Lock Lock patented technology quick couplers disconnection phase, or – During the vehicle fittings leak test	– Vehicle A/C system may have leaks at the HP and/or LP ports	– Empty the vehicle (follow the procedure guided by the displayed messages) – Replace HP and/or LP ports/valves inside ports

14. Maintenance forms

14.1 Vacuum pump oil change

Vacuum pump oil change record		
Date	Maintenance technician identification	Maint. tech. signature and stamp

Vacuum pump oil change record

Date	Maintenance technician identification	Maint. tech. signature and stamp

14.2 Filter dryer change

Filter Dryer Change Record		
Date	Maintenance technician identification	Maint. tech. signature and stamp

Filter Dryer Change Record

Date	Maintenance technician identification	Maint. tech. signature and stamp

Filter Dryer Change Record

Date	Maintenance technician identification	Maint. tech. signature and stamp

14.3 Refrigerant load cell calibration check

Refrigerant Load Cell Calibration Check Record			
Date	Result of check (pass/fail)	Maintenance technician identification	Maint. tech. signature and stamp

Refrigerant Load Cell Calibration Check Record

Date	Result of check (pass/fail)	Maintenance technician identification	Maint. tech. signature and stamp

14.4 Other checks/maintenance/repairs

Filter Dryer Change Record				
Job	Date	Result of check (pass/fail)	Maintenance technician identification	Maint. tech. signature and stamp

Filter Dryer Change Record				
Job	Date	Result of check (pass/fail)	Maintenance technician identification	Maint. tech. signature and stamp

15. Notes



MAHLE Aftermarket Inc., Service Solutions

10 Innovation Drive
York, PA 17402
USA

717-840-0678

www.servicesolutions.mahle.com