

OPERATION
&
MAINTENANCE
MANUAL

TC670V

Refrigerant Handling System

RTI TECHNOLOGIES, INC.

4075 East Market Street
York, PA 17402
800-468-2321
tech@rtitech.com

Manual P/N 035-80755-00

TC670V
CONVERTIBLE
RECYCLING MACHINE

This Recycling Machine was manufactured by RTI in compliance with all applicable Underwriters Laboratories (UL) and Society of Automotive Engineers (SAE) Standards and Specifications for Refrigerant Recycling Equipment.

Your machine is initially configured to recycle R12 **or** R134a.

An RTI Retrofit Kit is available for field conversion of this machine to recycle the alternate refrigerant for which it is now configured. This kit includes complete instructions, labels, filters, hoses with service couplers, and special tools required to make the conversion.

Once converted by an RTI Authorized Representative, a new Serial Label (included in the kit) will be affixed to the machine. This Serial Label will certify that the machine is then in compliance with all SAE and UL Standards and Specifications for Equipment to recycle the alternate refrigerant.

TABLE OF CONTENTS

TC670V

Start-Up Instructions	3
Safety Precautions	4
Filling the Charging Cylinder	6
Recover/Recycle	7
Oil Drain & Air Purge	9
Deep Vacuum	10
Hose Evacuation	11
Charge/High Side	12
Scheduled Maintenance & Filter Maintenance	14
Problems & Solutions	15
Flow Diagram	17
Schematic Diagram	18
FSC to ACME Adapter	19

CONGRATULATIONS: You have purchased one of the finest Recovery, Recycling, and Charging Machines available at any price.

Fill out and return the Warranty Card within 90 days to activate warranty and free lifetime technical support.

START-UP INSTRUCTIONS

- 1) Check for any shipping damage. Place a claim with carrier if damage is discovered.
- 2) Complete and return the Warranty Card to activate Technical Support and Warranty Coverage.
Warranty claims can not be honored without this warranty card on file.

BEFORE USING THE TC670V

Check for any shipping damage. Place a claim with carrier if damage is discovered.

DO NOT USE A DAMAGED UNIT.

Complete and return the Warranty Card to activate technical support service and warranty coverage.

Warranty claims can not be honored without this warranty card on file.

The TC670V should not be operated or serviced by any person who has not read all the contents of this manual. Failure to read and comply with these instructions or any one of the limitations noted herein can result in serious injury and/or property damage.

These general instructions describe normal operation and maintenance situations encountered with the TC670V. The instructions should not be interpreted to anticipate every possible contingency.

It is the responsibility of the owner/user to operate the TC670V in accordance with all specifications and laws which may apply.

The following pages contain rules for safe operation of the TC670V. Taking precedence over any specified rule listed herein, however, is the most important rule of all:

"USE COMMON SENSE"

A few minutes spent reading these instructions can make an operator aware of dangerous practices to avoid and precautions to take for his own safety and the safety of others.

A regular schedule of inspection of the TC670V should be established and records maintained with special attention given to Hoses, Compressor Oil Level, Vacuum Pump Oil Level and Filters.

SAFETY PRECAUTIONS

- ! Recover, Recycle, and Charge only the refrigerant for which the machine is configured.
- ! Wear safety glasses and protective gloves. Refrigerant has a very low boiling point and can cause frostbite.
- ! Follow the TC670V operating procedures sequentially to avoid prematurely disconnecting hoses or opening valves which may release refrigerant to the atmosphere.
- ! Do not expose the TC670V to moisture or operate in wet areas.
- ! Use the TC670V in locations with mechanical ventilation that provides at least four air changes per hour.
- ! Hoses used with the TC670V must have shutoff devices within 12 inches of the connection point to the system being serviced to minimize the introduction of Non-condensable Gas (Air) into the TC670V and the release of refrigerant when being disconnected.
- ! Disconnect power before performing any maintenance or service on the TC670V.
- ! Avoid using an extension cord with the TC670V. If necessary, use a good condition, UL listed, 3-wire grounded, #14 AWG extension cord of the shortest possible length.
- ! Connect the TC670V to a properly protected, grounded receptacle. Do not over load the circuit.
- ! Do not allow the TC670V to remain unattended in the Charge Mode with power On. The Charge Cylinder Heater will be energized creating a high pressure condition.

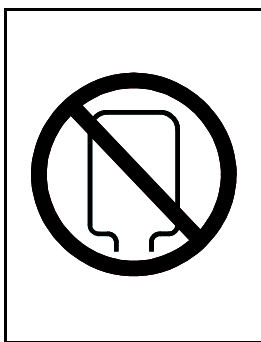

NEVER TURN THE CYLINDER UP-SIDE-DOWN.

DO NOT CONNECT THE TC670V TO THE LIQUID SIDE OF ANY A/C SYSTEM WITH A CAPACITY GREATER THAN 4 LBS.

REFRIGERANT IN A/C SYSTEMS HAVING LARGER CAPACITIES MUST BE RECOVERED FROM THE VAPOR SIDE ONLY.

NEVER CONNECT THE TC670V TO THE LIQUID PORT OF A CYLINDER OF REFRIGERANT TO FILL THE TC670V CHARGE CYLINDER.

FAILURE TO FOLLOW THE ABOVE MAY CAUSE THE TC670V COMPRESSOR TO FAIL AND VOID THE WARRANTY.

CAUTION

Avoid breathing refrigerant or lubricant vapor or mist.

Exposure may irritate eyes, nose and throat.

If accidental system discharge occurs, ventilate work area before resuming service.

Additional health and safety information may be obtained from refrigerant and lubricant manufacturers.

Special Considerations with R134a

R134a has been shown to be nonflammable at ambient temperature and atmospheric pressure. However, tests under controlled conditions have indicated that, at pressures above atmospheric and with air concentrations greater than 60% by volume, R134a can form combustible mixtures.

While it is recognized that an ignition source is also required for combustion to occur, the presence of combustible mixtures is a potentially dangerous situation and should be avoided.

Under no circumstances should any equipment be pressure tested or leak tested with Air/R134a mixtures. Do not use compressed air (shop air) for leak detection in R134a systems.

FILLING THE CHARGING CYLINDER

A/C Systems requiring service often do not have a full charge of refrigerant. To avoid unnecessary repositioning of hoses it is recommended that the TC670V be filled until about 3 pounds of liquid refrigerant can be seen in the Charging Cylinder Sight Glass. The Sight Glass is visible through a slotted opening on the front of the TC670V.

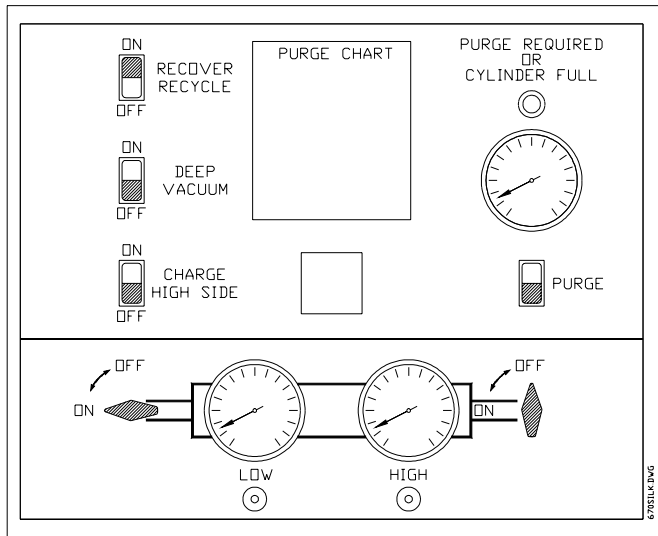
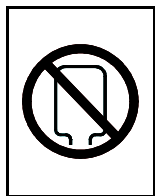

Figure 1 Filling the Cylinder

To fill the TC670V Charge Cylinder, refer to Figure 1 and follow these steps:

1. Connect the Low Side Blue Hose to the **VAPOR** port of a cylinder of new or recycled refrigerant. An adapter is provided with the TC670V (R134a) which permits the Field Service Coupler to be attached to the 0.500 ACME fitting on the cylinder of refrigerant.

If the cylinder has two ports, observe that the embossed marking on the cylinder knob says **VAPOR** or **GAS**. Do not rely on color coding of the knobs on the valves.



DO NOT CONNECT TO THE LIQUID VALVE.
DO NOT TURN THE CYLINDER UP-SIDE DOWN.

INTRODUCTION OF LIQUID INTO THE TC670V MAY DAMAGE THE COMPRESSOR AND VOID THE WARRANTY.

2. Press top (ON) of rocker switch marked RECOVER/RECYCLE.

The TC670V will recover and recycle refrigerant into the Charging Cylinder. Observe the liquid refrigerant level rise in the Charging Cylinder Sight Glass and when at approximately 3 lbs. close the valve on the refrigerant cylinder. Allow the TC670V to continue running until the Low Side Gauge shows a vacuum. This will evacuate the Blue Hose.

3. Press bottom (OFF) of rocker switch marked RECOVER/RECYCLE.

RECOVER/RECYCLE

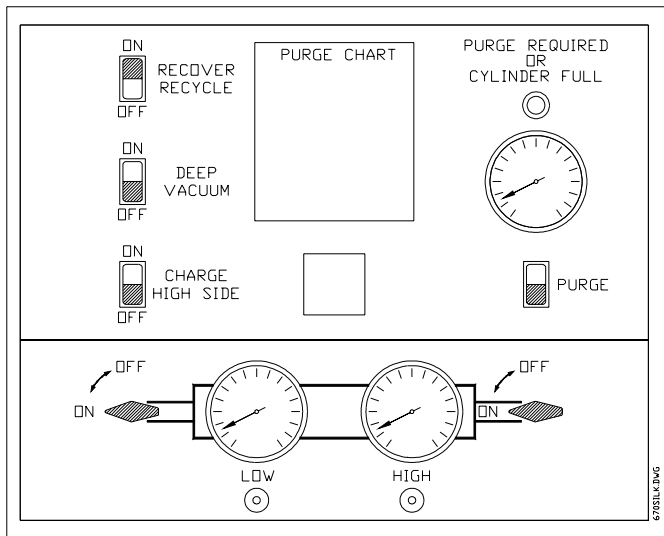

Figure 2 Recover/Recycle

To Recover/Recycle, refer to Figure 2 and follow these steps:

1. Attach Red and Blue Hoses to the A/C system per the vehicle manufacturer's instructions.

Note For R134a Machines

Field Service Couplings on the ends of Service Hoses are of a special design.

The valves have **LEFT HAND** threads which makes operation opposite to that of others.

To Close... Turn Counter-clockwise

To Open... Turn Clockwise

The valves **MUST BE CLOSED** before connecting or disconnecting Field Service Couplings.

2. Open High and Low Gauge Valves.
3. Open Red and Blue Hose Valves.
4. Press top (ON) of rocker switch marked RECOVER/RECYCLE.

The TC670V will automatically recover and recycle refrigerant from the A/C System until a vacuum is sensed. This vacuum level can be seen on the Low Side Gauge.

! DO NOT TURN THE TC670V OFF OR DISCONNECT HOSES !

A small quantity of Liquid refrigerant will probably still remain in the A/C System. This can be detected by observing an increasing pressure reading on the Low Side Gauge.

As pressure increases to a preset level, the TC670V will automatically cycle on and off to continue recovering refrigerant.

Allow this automatic sequence to repeat until the vacuum level remains constant for at least 2 minutes.

... NOTE ...

As refrigerant is processed by the TC670V, temperature variations can cause vapor to change to liquid which may temporarily settle in various internal components.

If a known amount of refrigerant has been introduced into the TC670V it may not all be seen in the Charging Cylinder Sight Glass.

This is normal and nothing to be concerned about. Refrigerant has not been lost.

The sight glass does not indicate the amount of refrigerant recovered. It is only accurate for determining the amount of refrigerant charged out to the vehicle A/C System while in the Charge Mode of operation.

5. Close Red and Blue Hose Valves.
6. Close High and Low Gauge Valves.
7. Press bottom (OFF) of rocker switch marked RECOVER/RECYCLE.

PURGE REQUIRED OR CYLINDER FULL LIGHT:

This Light will illuminate if either...

- 1) The Charging Cylinder has filled to capacity: Go to Page 12.

OR

- 2) Pressure on the Purge Gauge approaches 260 PSIG: Go to Page 9.

OIL DRAIN & AIR PURGE

Oil and Non-condensable Gas (Air) are separated from the recovered refrigerant and **MUST** be removed following **EACH** recycling procedure as follows:

1. **MOMENTARILY** press the top of the Purge Switch and hold until the pressure reading on the Pressure Gauge above this button drops one small graduation mark (approximately 10 PSIG).
2. **SLOWLY** open the Oil Drain Valve (on lower right side of TC670V) to vent Non-condensable Gas and drain any oil which may have been removed from the A/C System. A plastic cup is provided to collect and measure the oil.

Unless the A/C System had previously been overfilled, the TC670V will typically not remove more than a tablespoon of oil, making replenishment unnecessary.

Leave the Oil Drain Valve open.

3. Determine the room temperature.
4. Locate the pressure (PSIG) corresponding to this room temperature (° F) in the chart on the top of the TC670V. This chart is reproduced at the right.

If the pressure indicated on the gauge is greater than that determined from the chart...

SLOWLY press and hold the Purge Switch until the gauge pressure approximately equals that shown in the chart. Any Non-condensable Gas will be vented through the Oil Drain Valve.

5. Close the Oil Drain Valve.
6. Press the Purge Switch and hold for approximately 5 seconds. This permits any residual Non-condensable Gas to be recirculated for reprocessing during the next recycle procedure.

°F	R12	R134a
30	42	40
32	44	42
34	46	44
36	48	46
38	50	49
40	52	51
42	54	54
44	57	56
46	59	59
48	61	61
50	64	64
52	66	67
54	69	70
56	72	72
58	74	76
60	77	78
62	80	82
64	83	85
66	85	88
68	88	92
70	92	95
72	95	97
74	98	104
76	102	107
78	105	110
80	108	114
82	112	118
84	115	123
86	118	127
88	123	130
90	127	135
92	130	140
94	135	145
96	138	148
98	143	153
100	147	157
102	150	163
104	155	167
106	160	173
108	165	180
110	168	185
112	173	190
114	178	195
116	183	200
118	188	207
120	193	213

Purge Chart

VACUUM

If the A/C System is "opened" for replacing components, it is important to draw a vacuum on the system before recharging with refrigerant. The following steps should be followed:

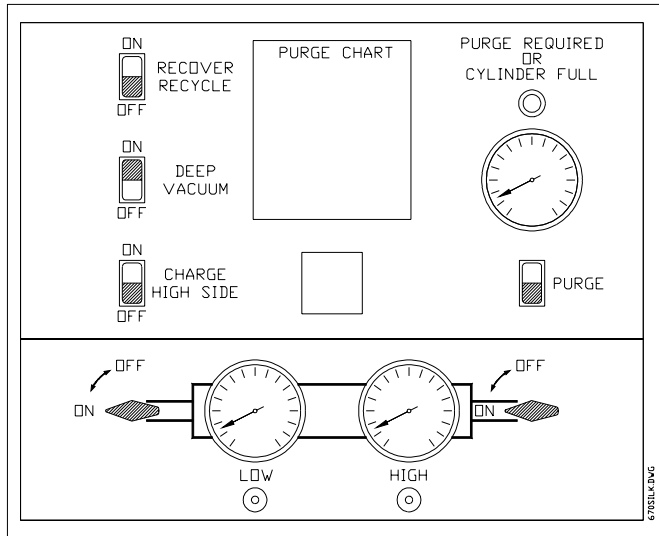

Figure 3 Vacuum

To Vacuum the A/C System, refer to Figure 3 and follow these steps:

1. Connect Red and Blue Hoses to the high and low sides of the A/C System.
2. Open Low and High Gauge Valves.
3. Open Red and Blue Hose Valves.
4. Press top (ON) of rocker switch marked DEEP VACUUM.
5. The Pump will start and the TC670V will start drawing a vacuum which will be indicated by a dropping pressure on the Low Gauge.

NOTE: If pressure is sensed at the Red and Blue Hoses on the TC670V, the Vacuum Pump will not start, as this would result in venting of refrigerant. If this occurs, perform the recover/recycle operation described earlier.

HOSE EVACUATION

It's important that Air not be introduced into the A/C System during a Charging procedure. If a Deep Vacuum procedure was performed previously, the following Hose Evacuation Procedure is not required. If the service valves on the hoses have been open, the following procedure must be performed:

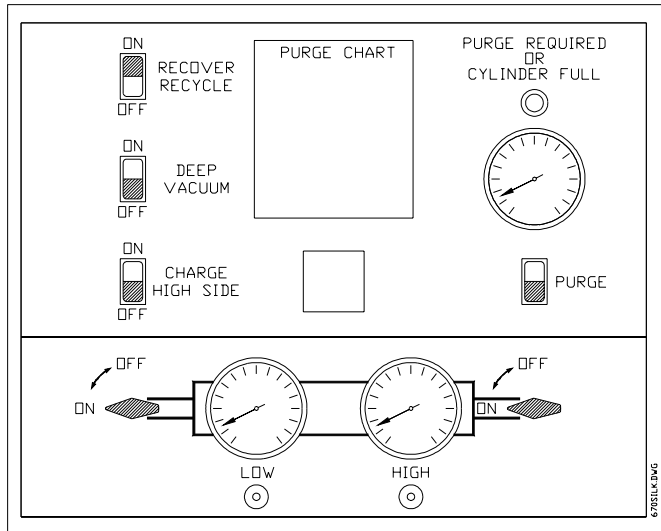

Figure 4 Hose Evacuation

To Evacuate Hoses, refer to Figure 4 and follow these steps:

1. Close Red and Blue Hose Valves.
2. Open High and Low Gauge Valves.
3. Press top (ON) of rocker switch marked RECOVER/RECYCLE.
4. Let the TC670V run until a vacuum is seen on the Low Side Gauge.
5. Turn High and Low Gauge Valves to OFF.
6. Press bottom (OFF) of rocker switch marked RECOVER/RECYCLE. All Air has now been removed from the Hoses.
7. Vent any Non-condensable Gas as described in the previous section.

CHARGE - HIGH SIDE

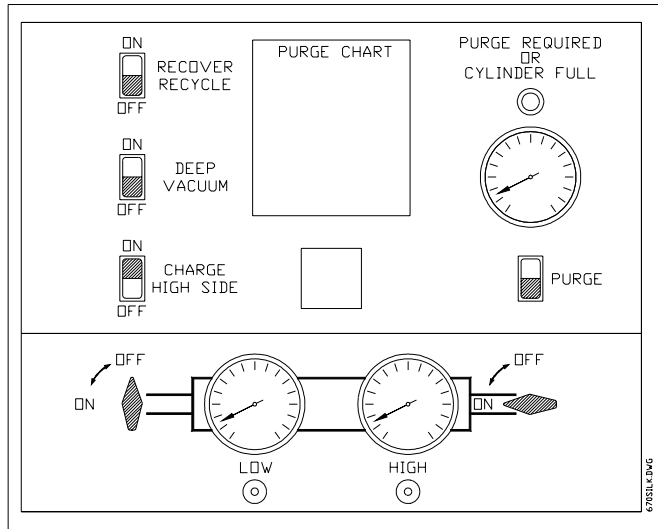

Figure 5 Charge - High Side

To Charge Refrigerant, refer to Figure 5 and follow these steps:

1. Perform Hose Evacuation described previously.
2. Connect Red Hose to the A/C System high side per the vehicle manufacturer's instructions. Do not open the hose valve.
3. Press top (ON) of rocker switch marked CHARGE/HIGH SIDE. The Charge Cylinder will now be heating to develop pressure for charging.
4. Open High Gauge Valve. The Low Gauge Valve and both Hose Valves should be closed.
5. Determine the refrigerant capacity of the A/C system to be charged. This data is usually printed on a tag located on the accumulator or under the hood of the vehicle. Convert this quantity to tenths of a pound for setting the TC670V charge indicator.

The following will determine where to set the indicator prior to starting the charge mode:

$$(\text{TC670V Liquid Level}) - (\text{A/C System Capacity}) = \text{Indicator Setting}$$

EXAMPLE: The level of liquid visible in the TC670V Charging Cylinder Sight Glass is 7.4 lbs. and the A/C system capacity is 3.2 lbs. The following calculation results...

$$(7.4) - (3.2) = 4.2$$

Therefore, the sliding indicator should be set at 4.2 lbs. in this example. When the liquid level lowers to the 4.2 lb. mark, a charge of 3.2 lbs. will have been delivered

NOTE... **The Sight Glass on the Charging Cylinder has markings for both R12 and R134a. Always use the correct scale for accurate charging.**

6. Open Red Hose Valve. **Do not start the Vehicle's Engine.** Refrigerant will flow into the high side of the A/C System. Closely monitor the liquid level as it lowers in the Charging Cylinder Sight Glass.
7. Close High Gauge Valve as soon as the refrigerant level drops to the sliding indicator.
9. Press bottom (OFF) of rocker switch marked CHARGE/HIGH SIDE.

The vehicle can now be started and the A/C system checked by monitoring Gauge pressures.

Evacuate the hoses per the preceding section "Hose Evacuation"

Always close all valves before disconnecting hoses.

NOTE: The preceding is the recommended method of charging with the TC670V.

Some vehicle manufacturers may specify connecting only to the Low Side of the A/C System. Always follow the manufacturer's recommended procedures. The above instructions would have to be modified accordingly.

SCHEDULED MAINTENANCE

BEFORE EACH USE ...

Check the oil level in the Vacuum Pump. It should be at the line on the sight glass. Oil should be changed periodically to maintain the vacuum pump efficiency at maximum.

WEEKLY ...

Check the oil level in the Compressor at least once a week.

The Oil Level Sight Tube is visible through a cut-out in the left side of the black Compressor Cover at the bottom of the TC670V.

The oil level should be visible in the small nylon tube.

If oil is not visible or is above the middle of the cut-out call Technical Support at 800-468-2321.

MONTHLY ...

Clean the Condenser to maintain high efficiency performance of the TC670V. Disconnect power and remove the Compressor Compartment Cover and blow compressed air through the cooling fins of the Condenser to remove any debris.

Do not bend the fins on the Condenser coil. Air flow will be restricted and cause damage to the TC670V. Replace the Compressor Compartment Cover before applying power to the TC670V.

FILTER MAINTENANCE

Two Combo Filters are installed on the rear of the TC670V.

The hour meter on the top control panel of the TC670V accumulates hours as refrigerant is being purified by the two filters during the recycle process.

Monitor the accumulated hours and change both filters at each twenty-five hour increment. It is good practice to replace both filters at least annually.

Call Technical Support (800-468-2321) for your nearest distributor of filters.

Short Combo Filter P/N:	026-80069-00
Long Combo Filter P/N:	026-80077-00

Remove and re-attach the foam on the short filter during replacement. Check for leaks immediately after changing filters during the first recover/recycle procedure.

PROBLEMS & SOLUTIONS

On rare occasion the TC670V may seem to be performing differently or not at all. Experience has shown that varying operating conditions can affect the performance characteristics of the TC670V. The temperature of the vehicle A/C System will affect how the TC670V performs.

Following are typical problems with explanations of the possible cause and solution.

PROBLEM: My TC670V worked fine all last Summer. I got it out today for the first service job this Spring and it is very slow in evacuating the system.

SOLUTION: Today's Spring temperature may be much lower than the average temperatures during the summer months. Maybe the vehicle was brought in from outside where the temperature is very low.

The refrigerant in the vehicle will not be under as high a pressure at lower temperatures and the TC670V will take longer to draw a vacuum. More cycles may be required to completely recover the refrigerant.

PROBLEM: I put 5 lbs. of refrigerant into the TC670V using the Recycle Mode. When I checked the sight glass on the Charging Cylinder, there was less than 5 lbs. I lost Refrigerant. The unit must leak.

SOLUTION: Due to temperature changes, some refrigerant may condense into liquid form and stay in tubes and other components in the circuit preceding the Charging Cylinder. This is normal and will explain why all refrigerant is not visible in the sight glass.

PROBLEM: I can not get the TC670V to draw a vacuum as indicated on the Low Side Gauge.

SOLUTION: Check Hoses and A/C system valve cores for restrictions.

PROBLEM: When I try to fill the Charging Cylinder from an auxiliary cylinder of clean refrigerant, the TC670V is really slow or shuts down.

SOLUTION: The auxiliary cylinder will cool due to the vaporization of refrigerant. This causes the pressure to decrease.

Use a heat belt to increase the speed of recycling by the TC670V.

PROBLEM: I turned a 30 lb. cylinder of new refrigerant up-side-down to pre-charge the Charging Cylinder with liquid. The Charging Cylinder didn't fill and now the TC670V won't recover from an A/C system.

SOLUTION: The TC670V has been overloaded with liquid refrigerant (See Safety Precaution Section at the beginning of this manual).

... WARNING ...

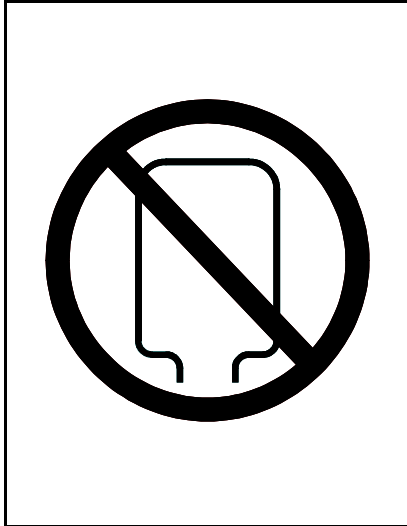

IF A CYLINDER IS TURNED UP-SIDE-DOWN, THE TC670V WILL OVERFILL WITH LIQUID REFRIGERANT. THIS OVER FILLS THE SUCTION ACCUMULATOR WITH LIQUID.

FROST ON THE OIL DRAIN OF THE TC670V IS A GOOD INDICATION OF THIS OCCURRENCE.

THIS SYMPTOM IS CAUSE FOR CONCERN AS LIQUID REFRIGERANT WILL BE FORCED INTO THE COMPRESSOR.

THIS CAN DESTROY THE COMPRESSOR AND WILL VOID THE WARRANTY.

The safest method to remove the excess liquid which has collected in the Suction Accumulator is to drain it from the Oil Drain as follows:

Draw a deep vacuum (25 to 29 InHg) on an empty cylinder and connect it to the Oil Drain Valve. Open the cylinder valve and the Oil Drain valve.

Close the valves and disconnect the cylinder after the liquid has been drawn into the cylinder. This refrigerant can now be recycled by the TC670V following normal recycling procedures.

If the above suggested solutions do not solve the problem, call the phone number shown on the Serial Label on the rear of the machine. One of our technicians will help diagnose the cause.

Please have the Serial Number available for reference.

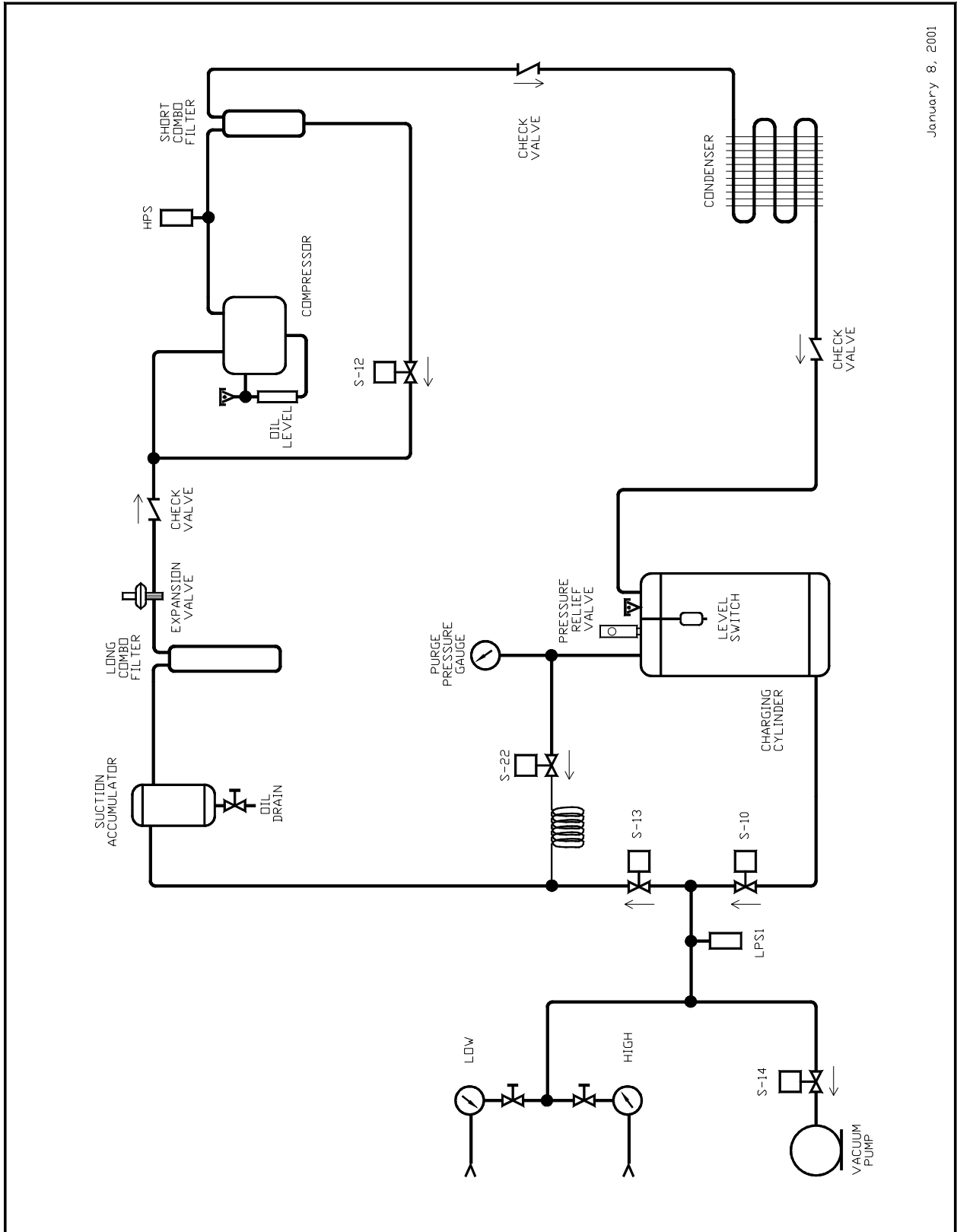

670V FLOW (2001)

570-80198-00

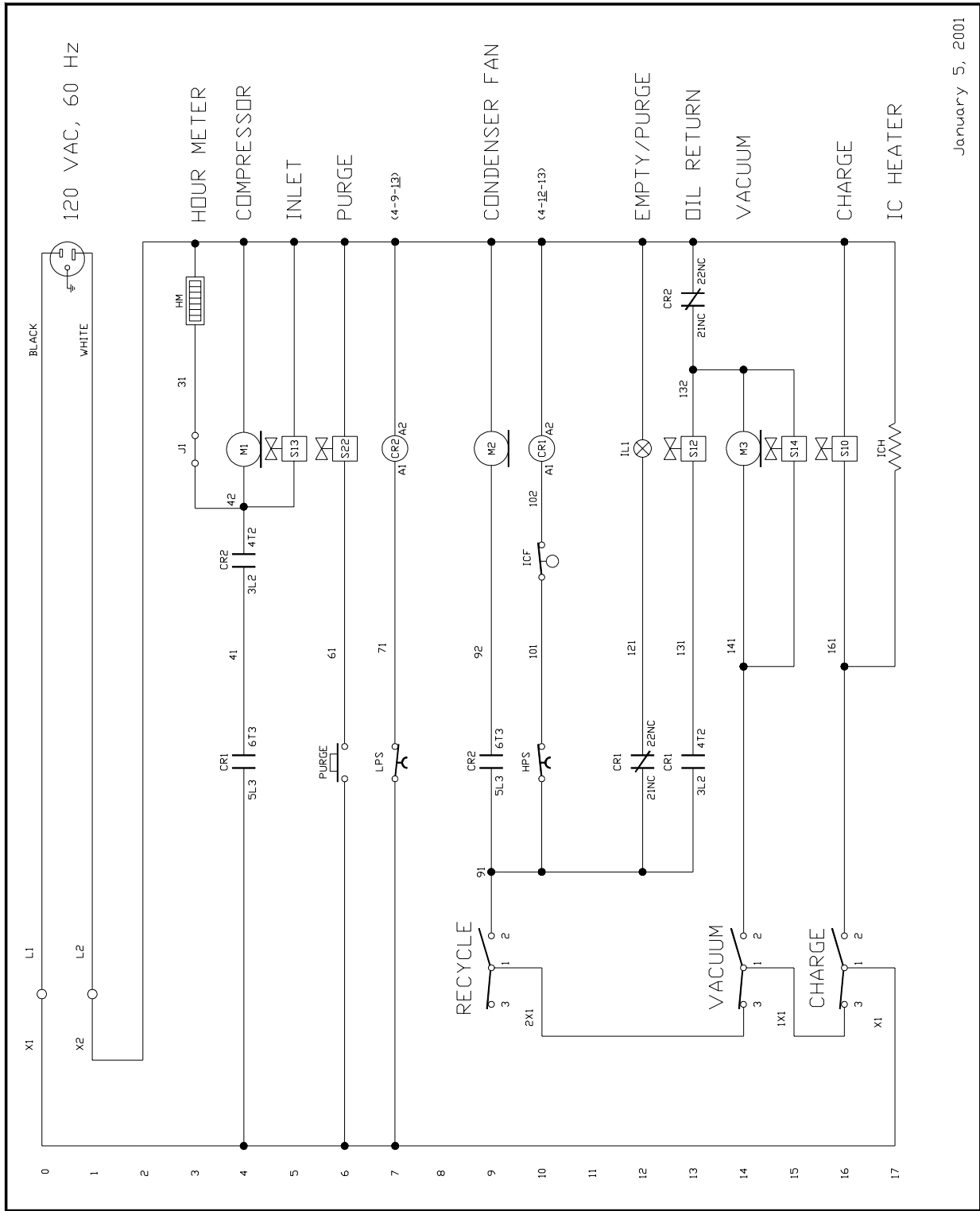

January 5, 2001

670V SCHEMATIC (2001)

570-80199-00

