

A'GRAMKOW A/S

Augustenborg Landevej 19
DK-6400 Sønderborg
Denmark

A/S Reg. No. 17 12 31
Telephone: 45 74 12 36 36
Telefax: 45 74 43 36 46
Telex: 5 23 18
Bank: Unibank No. 22 37

INSTRUCTIONS

RHS 900

**Recovery, Recycling, Evacuation
and Charging Station**

RHS 900

Contents

1. Application
2. Safety precautions
3. Components
4. Before use
 - Service couplings
 - Flow control - function and programming
5. Operating RHS 900
 - Test
 - Recovery/recycling
 - Evacuation
 - Oil charging
 - Refrigerant charging
 - Automatic process
 - Charging of Leakdetector dye
6. Maintenance
7. Flow control, programming
8. Specifications
9. Service set
10. Accessories
11. Trouble shooting
12. Pos. no. location
 - Mechanical diagram
 - Electrical diagram
13. Appendixes

Application

Your new RHS 900 station represents the latest in equipment for servicing air conditioning units (A/C units). The station is designed for refrigerants R12 and R134a. It can, and must, only be used for one of these refrigerants.

RHS 900 is a test, recovery/recycling-(draining/cleaning), evacuation, oil/refrigerant charging station and is thus able to perform a total process cycle in servicing A/C units for the automobile industry.

The recycling process is designed to follow SAE-standards J1989 and J2099 on recycled refrigerant for A/C units.

The six processes - from test to charging - are performed by operating six different process switches. This reduces the risk of error operation to a minimum. After each evacuation, RHS 900 automatically performs a vacuum test and indicates whether or not there is any leakage in the A/C unit. In addition, the station incorporates an automatic process which ensures that subsequent processes are performed fully automatically and in the correct sequence: evacuation, vacuum test and refrigerant charging.

Constant monitoring ensures that the automatic process sequence does occur correctly. Safety devices are built into the station to stop operation and indicate faults in processes, e.g. excessively high pressure, overcharging of charging cylinder.

During the recycling process a small quantity of oil is drained from the A/C unit. On completion of the recovery process this quantity can be drained into a measuring beaker. The same quantity of new oil must be filled into the A/C unit. Refer to the A/C unit instructions and use only the type of oil specified.

The filter drier has a very high capacity (300 kg) and is easy to replace during servicing.

A system built into the station ensures that non-condensable gases are automatically blown off and that the discharge of refrigerant to the atmosphere is kept to a minimum.

Before using RHS 900, read these instructions carefully to ensure that the processes are performed correctly.

Application

We reserve the right to make constructional and design changes and accept no responsibility for printing errors.

RHS 900 complies with European standards on "Safety and health" and is GS-approved.

See appendixes, "Declaration of Conformity" and TÜV Certificat.

Safety precautions

1. Always wear protective goggles and gloves when working with refrigerant.
2. Do not allow refrigerant to come into contact with the skin or eyes.
3. Before disconnecting RHS 900 from the A/C unit, make sure that the process is completed so that refrigerant does not escape to the atmosphere.
4. RHS 900 is for use only in dry indoor surroundings.
5. Disconnect the electrical supply before performing maintenance on RHS 900.
6. To reduce the risk of fire, avoid using an extension cord. If, however, an extension cord is necessary, it must have a minimum cross-sectional area of 2.5 mm².
7. In the event of fire, remove any external refrigerant cylinders.
8. When oil which accompanies the refrigerant drained from the A/C unit is tapped from the suction accumulator into the measuring beaker supplied, ensure that it is handled according to existing national legislation. A suitable container can be obtained from the refrigerant supplier.
9. Always brake the two front wheels of the station when parking.

Components

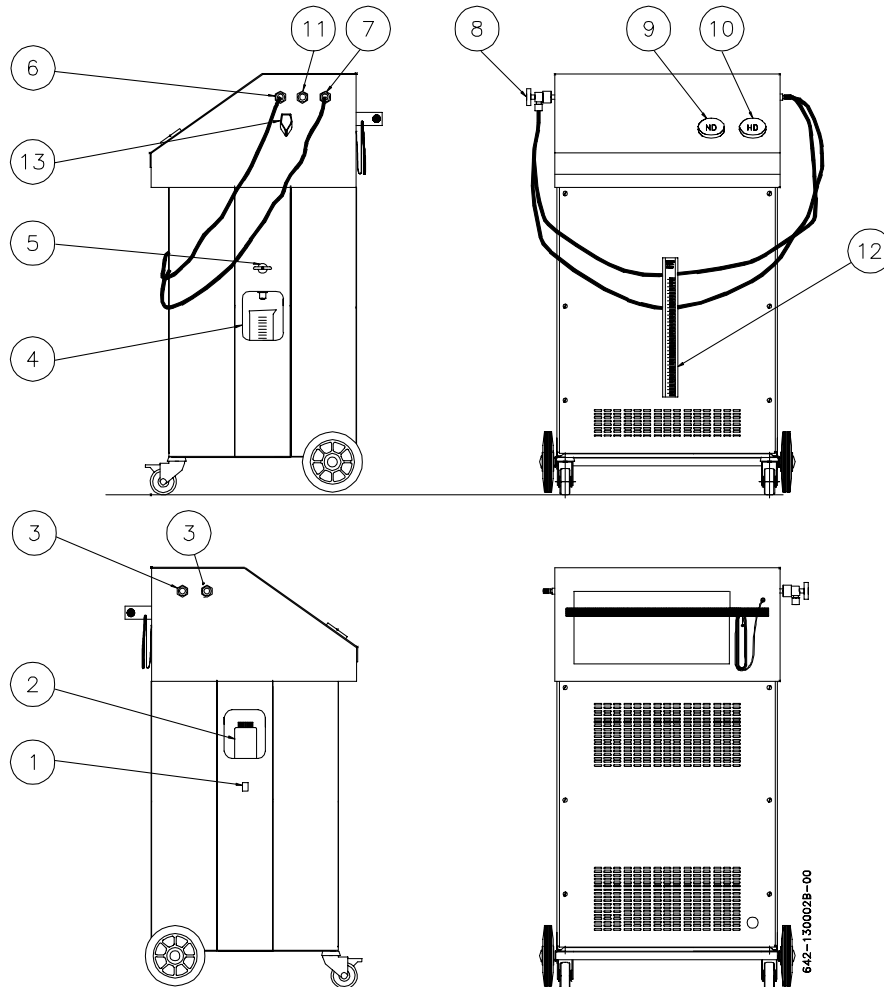

- 1) **Oil charging:** Oil charging switch.
- 2) **Oil tank**
- 3) **Parking sockets:** The high and low-pressure valves can be parked here.
- 4) **Measuring beaker:** For drained oil.
- 5) **Oil draining valve:** For draining oil received from the A/C unit.
- 6) **Connection:** Low-pressure, hose connection for the low-pressure side of the A/C unit.

Components

- 7) **Connection:** High-pressure, hose connection for the high-pressure side of the A/C unit.
- 8) **High and low-pressure valves.**
- 9) **Low-pressure gauge:** Indicates the pressure on the low-pressure side in the test function.
- 10) **High-pressure gauge:** Indicates the pressure on the high-pressure side in the test function.
- 11) **Connection:** For leak detector dye, or alternative type off oil.
- 12) **Levelindication:** Showing the actual level in the internal cylinder.
- 13) **Quickcharge:** For quick refilling of internal cylinder.

Components

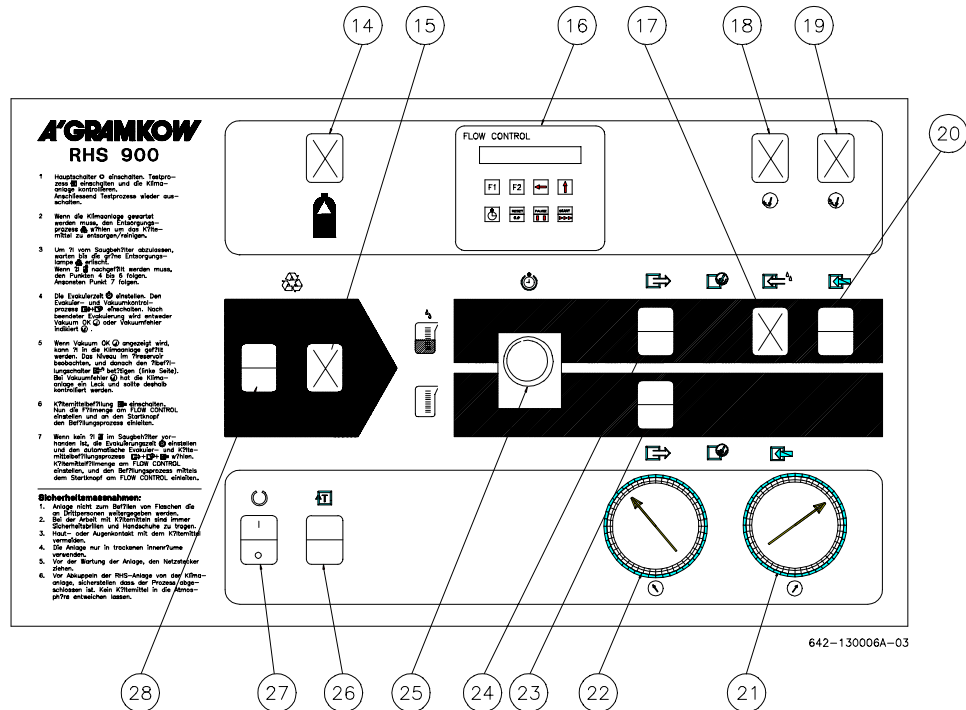

- 14) **Charging cylinder full - lamp (yellow):** lights up when the charging cylinder is full and stops the process.
- 15) **Compressor lamp (green):** remains on for as long as the A/C unit is subject to pressure, i.e. when vacuum reaches -0.2 bar the lamp goes out.
- 16) **Flow control:** Display and keyboard.
- 17) **Oil charging lamp (green):** lights up when the evacuation process is complete, and indicates oil charging. Oil charging is activated by the switch (pos. 1).
- 18) **Vacuum OK - lamp (white):** indicates that no leakage was found during vacuum test.
- 19) **Vacuum defect - lamp (yellow):** indicates that the vacuum has risen to more than -0.8 bar during the vacuum test.
- 20) **Refrigerant charging switch/lamp (green):** cuts in the refrigeration charging process and lights up when the connection is made.
- 21) **High-pressure gauge**

Components

- 22) **Low-pressure gauge**
- 23) **Automatic process switch/lamp (green):** cuts in the automatic process and lights up when the connection is made.
- 24) **Evacuation switch/lamp (green):** cuts in the evacuation process and lights up when the connection is made. After completed evacuation, a vacuum test is carried out automatically. The vacuum lamps light up to indicate “OK” or “Fault”.
- 25) **Evacuation timer:** Evacuation time can be set between 0 and 60 minutes.
- 26) **Reset/test switch/lamp (green):** cuts in the test process and lights up when the connection is made.
- 27) **Mains switch/lamp (white):** on/off switch for mains supply to station; lights up when the connection is made.
- 28) **Recovery switch/lamp (green):** cuts in the recovery process and lights up when the connection is made.

Before use

Check the following:

- whether the station has been damaged in transit - if so, contact supplier immediately;
- oil level in vacuum pump: it must not be below the centre of the sight glass. If the level is too low, see section MAINTENANCE for vacuum oil replenishment instructions;
- whether the mains supply is as stated on the station nameplate;
- whether the refrigerant in the A/C unit is as stated on the station nameplate.

Preparation:

- Connect mains plug to mains supply.
- Connect the red and blue hoses to their stubs on the side of the station. Blue hose to low-pressure side, red hose to high-pressure side. (See the next two pages.)
- Make sure that the shut-off valves on hoses and pos. 5 are closed.
- Connect high and low-pressure hoses to their respective sides (using the service couplings) on the A/C unit. (See the next two pages.)
- RHS 900 is now ready for operation.

Before use

Connection of service couplings

A/C unit with high and low-pressure connection

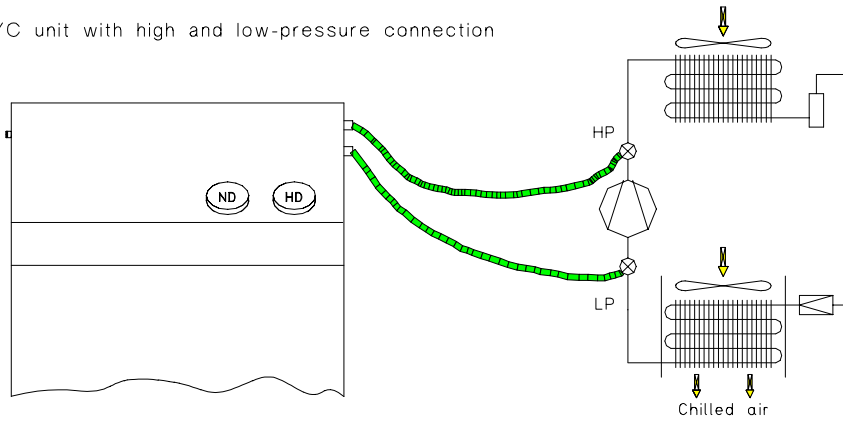

A/C unit with low-pressure connection only

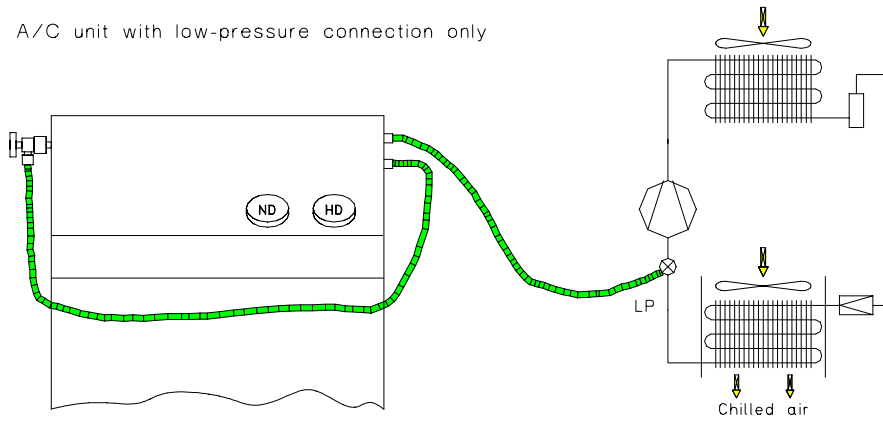

A/C unit with high-pressure connection only

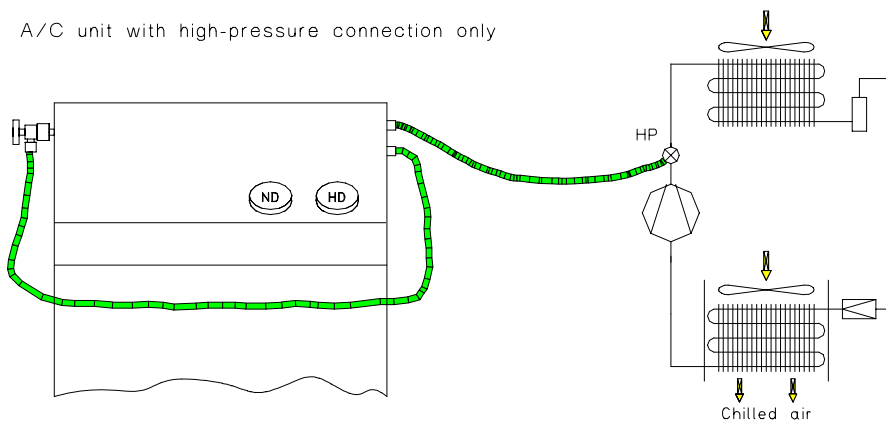

642-130020A-01

Before use

R134a

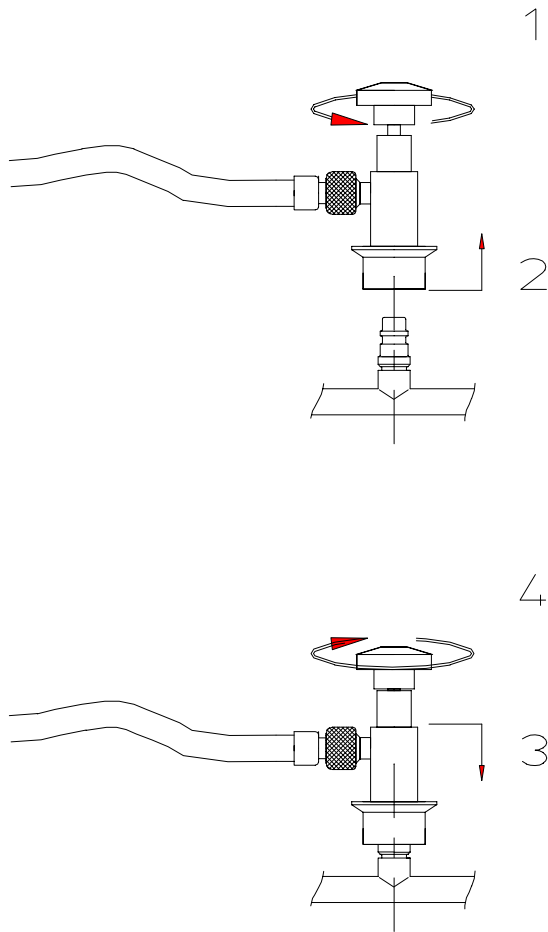

R12

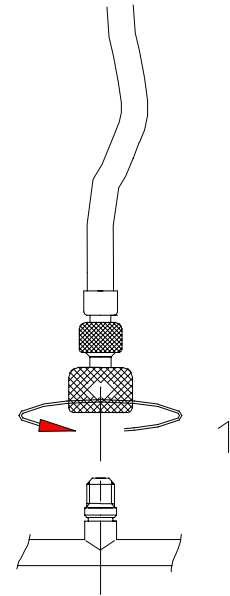

632-130082A-00

Before use

Flow control - function and programming

AGRAMKOW RHS 900

1. Hauptschalter **Q** einschalten, Testprozess **0** einstellen und die Klimaanlage kontrollieren. Anschließend Testprozess wieder ausschalten.
2. Wenn die Klimaanlage gestartet werden muss, den Erwärmsprozess **0** wählen und das Klimamittel zu entsorgen/reinigen.
3. Um **T** vom Saugfilter abzulesen, wählen Sie **0** (ohne Erwärmsprozess) ein. Nach dem Start wird die Temperatur an **0** angezeigt. Nach dem Start **0** bis **9** folgen. Antworten Punkt 7 folgen.
4. Die Evakuierzeit **0** einstellen. Den Evakuier- und Vakuumierprozess **0** einschalten. Nach beendeter Evakuierung wird entweder Vakuum **OK** oder Vakuumfehler **indiziert**.
5. Wenn Vakuum **OK** angezeigt wird, kann **T** in die Klimaanlage eingelesen werden. Die Klimawerte im Freerun-Modus beobachten, und danach den Überladeschutz **0** kalibrieren (siehe Seite). Bei Vakuumfehler **0** hat die Klimaanlage ein Leck und sollte deshalb kontrolliert werden.
6. Klimamittelbefüllung **0** einschalten. Nur die Füllmenge am **FLOW CONTROL** einstellen, und am Startknopf den Befüllungsprozess einstellen.
7. Wenn kein **T** im Saugfilter vorhanden ist, die Evakuierzeit **0** einstellen und den qualitativen Evakuier- und Klimamittelbefüllungsprozess **0** wählen. Klimamittelmenge am **FLOW CONTROL** einstellen, und den Befüllungsprozess mittels dem Startknopf am **FLOW CONTROL** einstellen.

Sicherheitsmaßnahmen:

1. Anlage nicht zum Befüllen von Flaschen die in Drittpersonen weitergegeben werden.
2. Bei der Arbeit mit Klimamitteln sind immer Sicherheitsbrillen und Handschuhe zu tragen.
3. Haus- oder Augenkontakt mit dem Klimamittel vermeiden.
4. Die Anlage nur in trockenen Innenräume verwenden.
5. Vor der Wartung der Anlage, den Netzstecker ziehen.
6. Vor Abkuppen der RHS-Anlage von der Klimaanlage, sicherstellen dass der Prozess abgeschlossen ist. Kein Klimamittel in die Atmosphäre entweichen lassen.

FLOW CONTROL

642-130001A-01

FLOW CONTROL

F1 F2 ← ↑

⏸ RESET PAUSE START

o.o

The Flow Control system - the “FC” - monitors and controls the different processes of RHS 900. FC can be programmed by the operator.

Variables can be altered when process switch TEST is selected (see Section 7 for further information).

Before use

The functions of the various processes are described below.

TEST: - Operation time
 - Oilchange
 - Maintenance time (for filter replacement)
 - Variable programming.

RECYCLING:- - Display is showing processcycle and indicating the elapsed time.

EVACUATION: - Display is showing processcycle and indicating the elapsed time.

PRESSURERIZING: - Indicates that pressure is being built up for 2 min. , and that the charging process will follow automatically.

CHARGING: - Monitoring/control of charging process
 - Data storage
 - Fault indication
 - PAUSE (charging process cuts off)

Note: Operation and display texts for the various processes are described in the operating instructions.

Operating RHS 900

Test

- Open valves on service couplings.
- Activate test switch.
- Station mains switch ON (pos. 27).
- The station now performs a test function. Connect the automobile A/C unit. The high and low-pressure gauges now indicate whether the A/C unit needs maintenance work.
- Perform a condition diagnosis in accordance with the A/C unit supplier instructions.

Operating RHS 900

Test

- FLOW CONTROL function in TEST process:

On pressing the clock-key the display shows how much time remains before servicing is necessary.

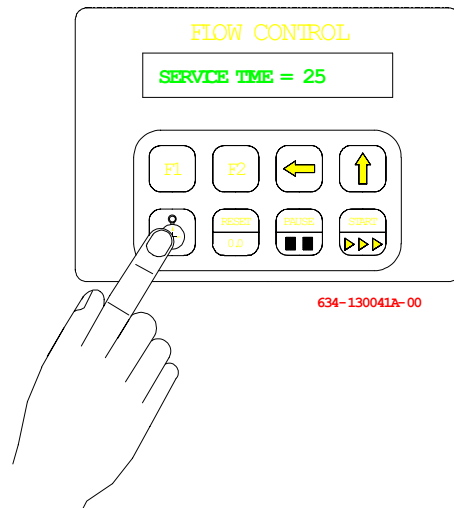

On pressing the clock-key and “F1” simultaneously the display shows for how long the unit has been in operation.

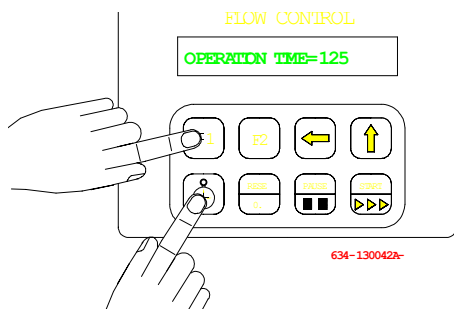

Operating RHS 900

Recovery/recycling

- Press process switch (pos. 12) RECOVERY.
- Open valves on service couplings (pos. 8).
- The compressor starts and the RECOVERY lamp (pos. 15) lights up.
- The recovery process now proceeds automatically until the A/C unit is empty.
- The recovery process is finished when the RECOVERY lamp goes out. Wait 5-8 minutes to ensure that the unit is completely empty.
- When the A/C unit is empty, the quantity of oil drained from the unit must be measured. This can be done by opening the oil drain valve (pos. 5) and allowing the oil to flow into the measuring beaker supplied. The A/C unit must be filled with a corresponding amount of new oil. See "Oil charging". Follow the A/C unit supplier instructions and use only the type of oil specified.
- At this point, if it is necessary to repair the A/C unit the service couplings can be disconnected from the unit and servicing performed. If no repairs are necessary, the evacuation process can be performed.

NOTE:

At the level indication Pos 12 it can before start of the recycling proces, be noted the actual level of refrigerant. In this way, the recovered amount of refrigant can be calculated after finishing the recovery process.

Operating RHS 900

- The recovery and recycling time can be read from the FLOW CONTROL display.
- If the A/C unit requires oil charging, the process sequence must be EVACUATION, OIL CHARGING and REFRIGERANT CHARGING. If oil replenishment is not necessary, AUTOMATIC PROCESS (page 5.8) can be selected.

Evacuation

- Set the evacuation time on the timer (pos. 25).
- Press process switch (pos. 24) EVACUATION.
- If overpressure remains in the A/C unit, the vacuum pump will not start. If this is the case, press RESET/TEST and then the RECOVERY switch. Now wait until the compressor has created underpressure. The RECOVERY lamp (pos. 15) will go out and EVACUATION must be pressed again.
- After evacuation is complete, a vacuum test follows automatically (leakage test). If for a period of 3 minutes the vacuum remains lower than -0.8 bar, the white lamp VACUUM OK lights up.

If the vacuum rises above -0.8 bar, the yellow lamp (pos. 19) lights up to indicate VACUUM FAULT. If this is the case the leakage must be located and repaired.

IMPORTANT! If the evacuation time selected is too short, the oil in the A/C unit may still contain a small quantity of refrigerant. During vacuum test such refrigerant might cause a vacuum fault even though no leakage exists. Thus always evacuate minimum 30 minutes.

Operating RHS 900

Oil charging

IMPORTANT! When the A/C unit has been charged with refrigerant, oil charging is not possible. Oil charging must always be performed before refrigerant charging.

Oil charging is only possible after evacuation is complete and only when the lamp VACUUM OK (pos. 18) lights up.

Proceed as follows:

- Check to make sure that there is sufficient oil in the oil tank or replenish the tank as described below.
- Press the oil charging switch and observe the level in the oil tank (pos. 2) until the quantity required has been sucked into the A/C unit.
- The A/C unit is now ready for refrigerant charging. See instructions for refrigerant charging.

Oil tank replenishment

When the level in the oil tank has reached the lower edge of the scale, oil replenishment is necessary. Simply remove the oil tank cover and refill with oil.

Operating RHS 900

Refrigerant charging

- Before the charging process, check the quantity of refrigerant necessary for the A/C unit concerned. This information can be found on a nameplate in the vehicle engine compartment.
- Press process switch (pos. 20) REFRIGERANT CHARGING.
- If PAUSE is indicated, push the RESET /0.0 button and following the START-button to accept it.
- Key in the charging quantity required:
 - The value of each numeral can be changed with the arrow-up key.
 - Use the arrow-left key to move to the numeral to be changed, then use the arrow-up key to change the value of that numeral.

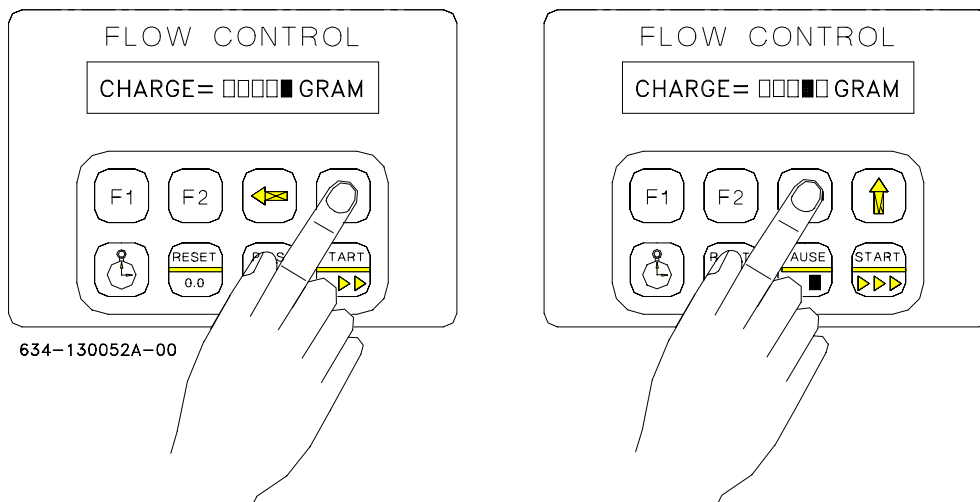

Operating RHS 900

- The charging process must be cut in with the START key.

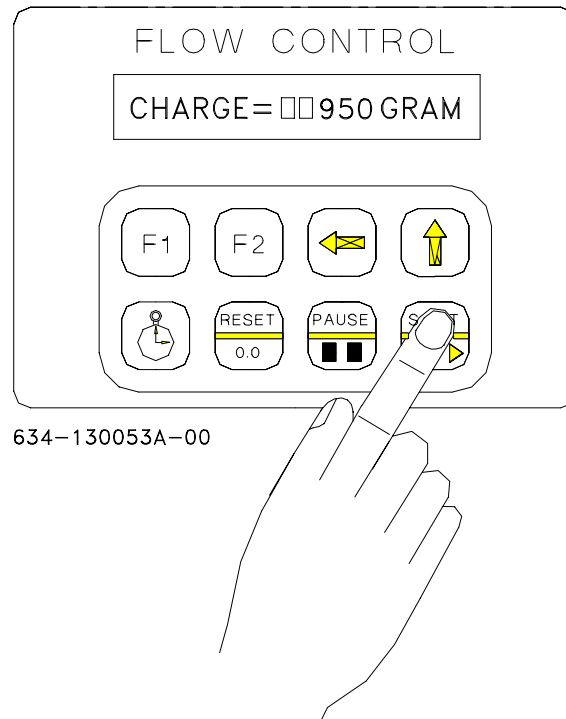

- The charging process can be monitored on the display.
- If the process has to be stopped for a short period, press the PAUSE key.
- When the process is to be cut in again, press the START key.
- If the entire process is to be annulled, first press the PAUSE key and then the RESET key. Now press the START key to confirm the annulment.

Operating RHS 900

For further information on trouble shooting and GAS, BLOCK-ALARM etc., see Section 7.

- It is now possible to check whether the A/C unit has been charged with the correct quantity of refrigerant. To do this, start the unit and then read off high and low pressure from the appropriate unit pressure gauges. The correct pressures are given in the A/C unit supplier instructions.
- When charging is complete, wait 30 seconds before disconnecting quick-coupling hoses from the A/C unit.
- As hoses will contain refrigerant residue, drain them by closing the service hose valves and by pressing the process switch RECOVERY. The compressor will then automatically empty refrigerant from the hoses.

NOTE:

To guarantee the charging accuracy, the charging amount lost in the service hoses, must be compensated. The losses are depending on variables such as length of the hoses and ambient temperature.

Automatic process

When it is not necessary to charge the A/C unit with oil, AUTOMATIC PROCESS can be selected. Evacuation, vacuum test and refrigerant charging will then be performed automatically:

- Set the evacuation time on the timer (pos. 25).
- Press process switch (pos. 23) AUTOMATIC.
- If pressure remains on the A/C unit, the vacuum pump will not start! If this is the case, press RESET/TEST (pos. 26) and then RECOVERY SWITCH (pos. 12) and wait until the compressor has built up underpressure (green recovery lamp pos. 15 goes out). AUTOMATIC can then be reactivated.
- The required quantity of refrigerant must now be entered in the Flow Control (see description under process REFRIGERANT CHARGING).
- When evacuation is complete, a vacuum test follows automatically (leakage test!). If within 3 minutes the vacuum stays below -0.8 bar the lamp VACUUM OK lights up and REFRIGERANT CHARGING follows automatically.

Operating RHS 900

- If, however, vacuum rises above -0.8 bar the yellow lamp indicates VACUUM FAULT (pos. 19) and no refrigerant is charged.
- If in any case refrigerant is to be charged, refrigerant charging can be started by activating the CHARGING switch.
- Before the actual charging process starts, the display will be indicating “ PRESS. RIZING” in 2 minutes, where pressure is build up.

NOTE:

If the charging cylinder needs to be drained or replenished, connect the high pressure service coupling to an external refrigerant bottle, (use the delivered adapter if necessary). Open the high pressure valve on the RHS unit and the service coupling.

If the charging cylinder must be drained, select the CHARGING process, (make sure the refrigerant bottle can hold the amount).

If the charging cylinder must be replenished, select the RECYCLING process. Also open the QUICKCHARGE-valve (pos.13), and wait till the desired amount has been filled into the cylinder. Opening the Quickcharge valve will speed up the process,- but remember to close the valve again during normal Recycling process, otherwise the refrigerant quality can not be guaranteed.

Charging of Leakdetector Dye

The RHS900 is equipped with a third conection (pos. 11), wich can be used for charging leakdetector dye or another oiltype if needed:

- Connect the oilcharging bottle (pos.B) or the Tracer Kit (pos.C) to the connection pos.11, and wait untill the Evakuation process has been completed.
- When using the oilcharging bottle , follow the instruction on the bottle.
- When using the Tracer Kit, first connect a Tracer on the Kit. Then open the valve, until the colored dye has disapeared from the Tracer. Then close the valve again.

Maintenance

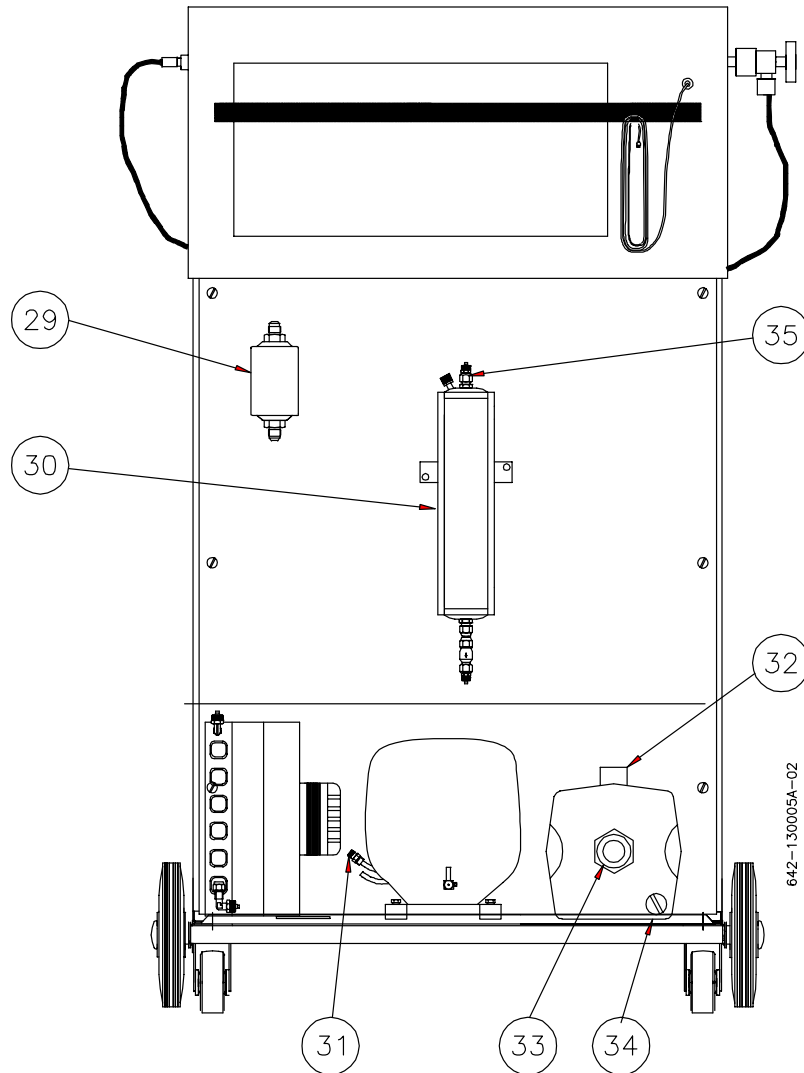

- 29) Acid filter.
- 30) Filter drier.
- 31) Charging stub.
- 32) Charging stub.
- 33) Oil level vacuum pump.
- 34) Oil draining plug.
- 35) Nut.

Maintenance

To observe the warranty on RHS 900, all components used for maintenance must be identical to those in the service set, see Section 9

To ensure problem-free operation of RHS 900, the station must be maintained in accordance with the following:

The power supply to the station must be switched off.

For each 25 operating hours:

The vakuumpump oil in time absorbs moisture, which in the end gives bad vacuum level. Therefore the oil must be changed frequently. It will be indicated in the FLOWCONTROL when to change the oil. After 25 operating hours OIL CHANGE will blink for 2 min. in the display. Resetting is done automatically.

Change oil as follows:

- Place an oil cup below the oil draining plug Pos. 34, and loosen the plug. Let the old oil flow into the oil cup.
- Take off the oil charging stub Pos. 32.
- Mount the oil draining plug again, and pour in new oil into the oil charging stub Pos 32, until the oil level can be seen in the center of the sight glass Pos. 33.

For each 75 operating hours:

Via the FLOW CONTROL it is possible to see when maintenance is necessary by simply pressing the clock-key on the FLOW CONTROL during the test process.

The FLOW CONTROL gives an alarm 5 hours before maintenance is due.

SERVICE will flash for 10 seconds in the display.

On reaching 75 hours of operation, SERVICE flashes for 2 minutes in the display.

After maintenance is complete, the number of operating hours to the next maintenance must be set at zero as follows:

Maintenance

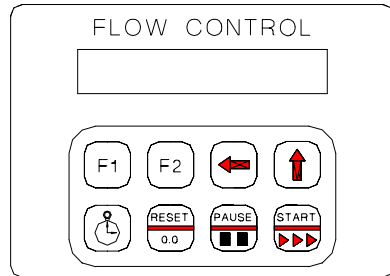

O = OPERATION
D = DISPLAY

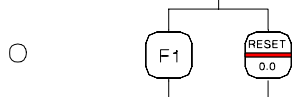
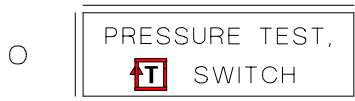

Press both keys for 10 seconds.

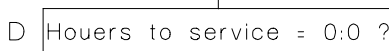

Press to confirm.

642-130022A-00

Maintenance

The condenser surface must be kept clean:

- Remove the rear panel of the station (4 screws).
- Clean the condenser with compressed air and perhaps a soft brush. Be careful not to bend the fins since this would reduce the air flow and impair condenser capacity.
- Replace rear panel.

Check the oil level in the vacuum pump:

- Oil level check: Start the evacuation process and allow it to run for a few minutes. Switch off the process and wait for one minute and check then the oil level in the sight glass (pos. 33). Replenish with oil if below the center of the sight glass.
- Remove cap (pos. 32) to replenish vacuum pump.
- Replenish (slowly) with vacuum oil to the correct level.
- Replace cap.

Check oil level in compressor:

- Switch on the mains switch and press the recovery switch.
- Wait until the underpressure has reached 0 bar and switch off the main switch. **Do not** wait, until the RECOVERY/RECYCLING-lamp goes out - otherwise the pressure will be built up again in the evaporator.
- Unscrew the cap of the oil fill stub (pos 31).
- The oil level should be seen at the oil fill stub.
- When necessary, recharge the oil using the syringe supplied - up to the mentioned level. Each time an amount is injected, wait 5 minutes to allow the oil to 'settle'.
- Screw cap on oil fill stub.

Maintenance

For each 75 operating hours:

Replace acid filter (pos. 28)

- Remove front panel (4 screws).
- Replace filter by loosening the two 3/8" flare nuts and fit new filter. Use only new filters fitted with protective caps on connections and make sure the filter is oriented correctly (arrow pointing downwards).

Replace filter drier (pos. 29)

- Remove filter by first loosening end unions. Slowly loosen nuts (pos. 35) and take out filter.
- Draw insulation off filter drier.
- Draw insulation on the new filter drier.
- Refit the new filter on station and connect unions.

On replacing filter driers a small quantity of refrigerant escapes - therefore follow the appropriate safety precautions.

Flow control - programming

The following programming is possible:

- 1) Display text language
- 2) Contrast/illumination of display background

The following variables for the charging process can be programmed:

- 1) The additional quantity of refrigerant to be charged to compensate for the quantity in the hoses.

The following faults can be set at zero in the charging process:

- 1) Gas alarm
- 2) Block alarm

The processes that can be changed are described in the following:

Flow control - programming

Changing the language:

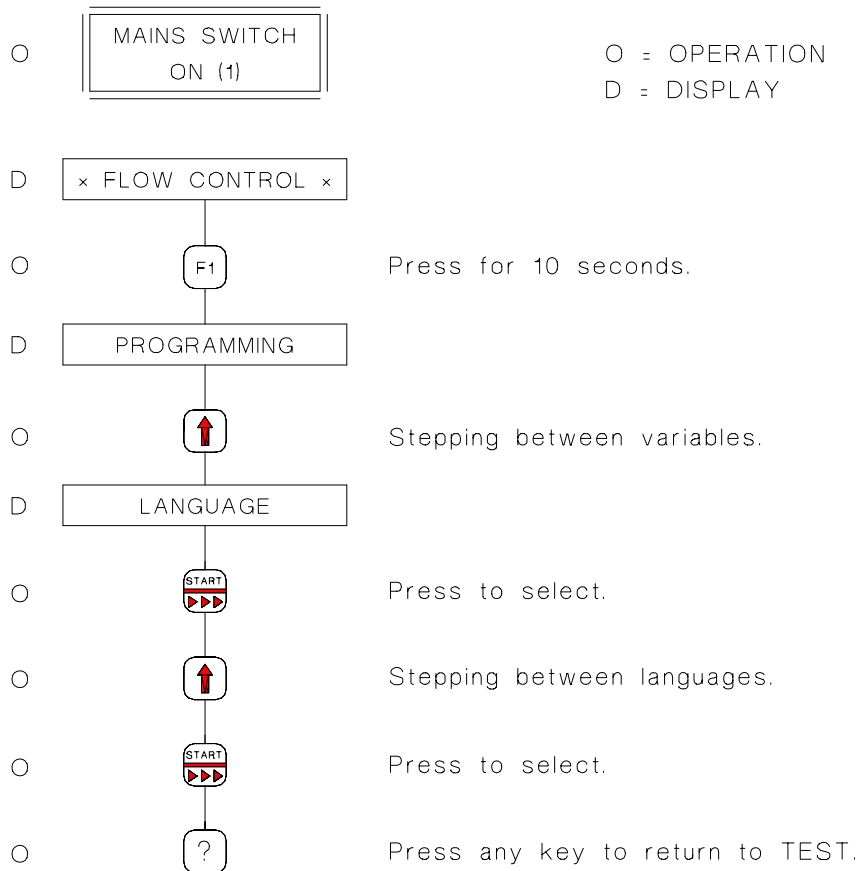
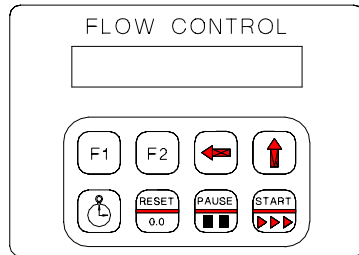

642-130023A-00

Flow control - programming

Changing contrast/illumination of display background.

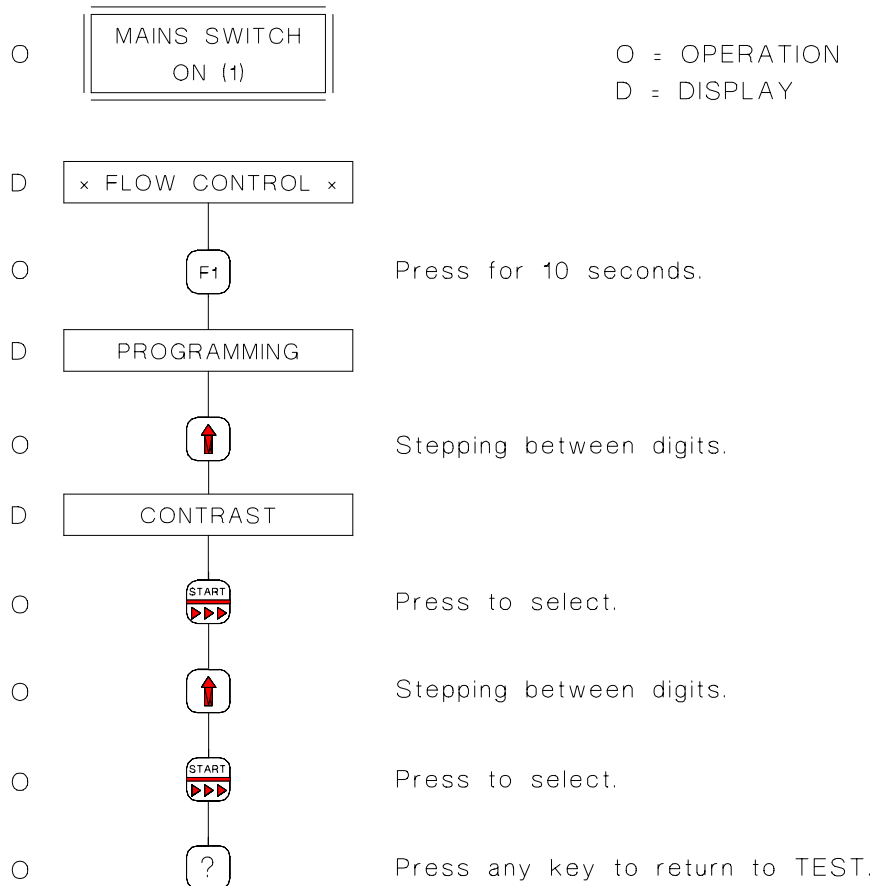
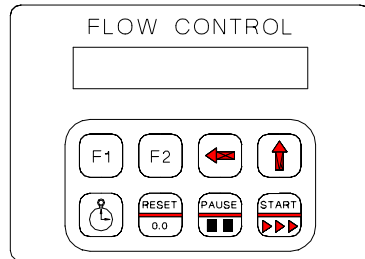

Flow control - programming

Compensation for refrigerant still in the charging hoses during charging.

An extra stroke corresponds to approx. 5 g.

The factory setting is 25 g corresponding to the maintenance hose supplied with the station, and an ambient temp. Of 20 °C.

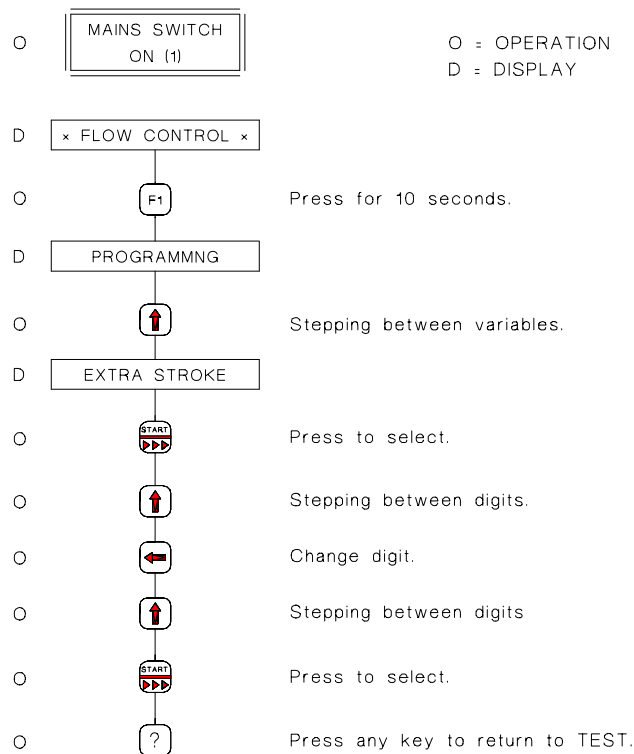
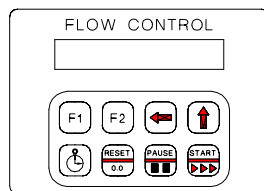

642-130025A-00

Resetting of Gasalarm/Block Alarm

Flow control - programming

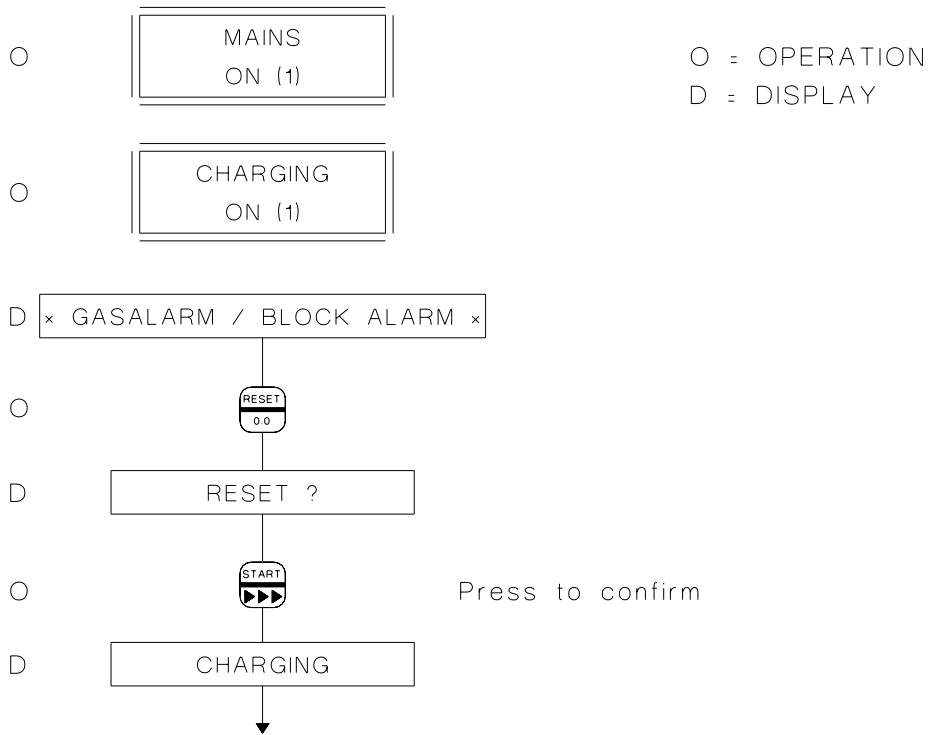
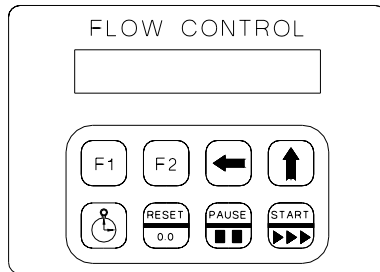

642-13001B-00

Flow control - programming

If the gas alarm cannot be turned into OFF position the charging cylinder is probably full. Shift to Process draining/recycling and connect refrigerant bottle.

If the block alarm cannot be turned into OFF position the valve on high pressure hose is closed or the hose is blocked. Check hose gaskets or contact the supplier.

Specifications

General:

Supply voltage:	See nameplate
Amperage:	See nameplate
Power consumption:	See nameplate
Starting current:	See nameplate
Weight:	95 kg
Dimensions:	1030 x 670 x 800 mm

Test function:

High-pressure gauge:	0 to 34 bar
Low-pressure gauge:	-1 to 8 bar

Recovery/recycling process:

Refrigerant:	See nameplate
Oil level measurement:	Drain at side of station, measuring beaker supplied
Recycling capacity:	4 kg/h (3-5 vehicles/h)
Non-condensable gases:	Automatic blow-off, temperature-compensated
Suction accumulator:	2,4 L.
Charging capacity:	7 Kg. Optional 14 Kg.
Charging accuracy:	±2% with 40 cm. hoses.
Dryer:	Exchangeable (after 75 operating hours)

Evacuation process:

Suction capacity:	Approx. 3 m ³ /h
Vacuum level:	< 0.5 mbar absolute
Oil charging:	Oil reservoir : 250 ml

Operating panel

Specifications

Mains switch - white:	Power supply cut in
Test switch - green:	Test process in function
Recovery switch - green:	Recovery process in function
Recovery lamp - green:	Pressure in A/C unit
Evacuation switch - green:	Evacuation process in function
Oil charging switch - green:	Oil charging in process
Refrigerant charging switch - green:	Refrigerant charging in process
Automatic process switch - green:	Evacuation of A/C unit, vacuum check and refrigerant charging in process
Vacuum check lamp - green:	Vacuum OK
Vacuum check lamp - yellow:	Vacuum fault / leakage
Charging cylinder lamp - yellow:	Cylinder full

Specifications

Service and maintenance

Acid filter:	Replaceable, 3/8" SAE
Oil filter:	0.6 µm (built into oil separator)
Filter drier:	Replaceable, (capacity 75 hours or 300 kg refrigerant)
Compressor oil level:	Sight glass + charging stub
Vacuum pump oil level:	Sight glass + charging stub
Safety equipment:	Mechanical safety valve on charging cylinder Overfilling protection on charging cylinder Suction pressure regulator on compressor High-pressure control on compressor
Code number of RHS 900:	See nameplate

Service set

Quantity	Description	Code no.
1	Acid filter	069-2910127
1	Filter drier	069-7480044
2	Gasket for filter drier	065-7751920
0.25 l	Compressor oil - mineral	290-0001250
0.25 l	Oil for vacuum pump	290-0001272

To order complete service set - state code no. (see nameplate).

Accessories

Qty	Description	Code no.
1	Operating instructions, English	642-400012A
1	Service coupling, high pressure (R134a)	290-7480095
1	Service coupling, low pressure (R134a)	290-7480096
1	Service coupling (R12)	066-7390234
1	Service hose, blue (R134a) = 72"	634-140002A
1	Service hose, red (R134a) = 72"	634-140001A
1	Service hose, blue (R12) = 180 cm	080-4665015
1	Service hose, red (R12) = 180 cm	080-4665017
1	Service hose, yellow (R12) = 90 cm	080-4665002
1	Gasket for R134a hose, gasket outside dia. 8.3 mm	087-7481010
1	Gasket for R134a hose, gasket outside dia. 9.6 mm	087-7482130
1	O-ring for R134a hose	087-7481341
1	O-ring for R134a hose, gasket outside dia. 14 mm	087-7470210
1	Gasket for R12 hose, gasket outside dia. 8.5 mm	066-7750950
1	Injector, 60 ml	290-5390268
1	Oil beaker, 250 ml	290-0780096
1	Oil beaker, 225 ml, with handle	146-7489012
1	Label, English operating instructions	642-420010A
1	Oilcharging bottle, 300 ml German instruction	642-040003A
1	Oilcharging bottle, 300 ml Englisch instruction	642-040003B
1	Tracer Kit, R134a	643-040002A
1	Tracer Kit, R12	634-040007A

Trouble shooting

Test process

Problem	Fault	Remedy
Pressure gauge shows no pressure	1. and 2. Valve not opened 2. No refrigerant in A/C unit	1. Open high and low-pressure valves on service couplings 2. Repair A/C unit.
Pressure gauge shows the same reading all the time	1. A/C unit defective 2. A/C unit not cut in	1. Empty A/C unit and repair 2. Cut in A/C unit

Recovery process:

Problem	Fault	Remedy
Recovery process does not start - green recovery lamp does not light up	1. RHS 900 not cut in 2. Valves not opened 3. No refrigerant in A/C unit 4. System pressure is 16 bar 5. Internal cylinder full 6. Internal component fault	1. Cut in RHS 900 2. Open high and low-pressure valves on service couplings 3. Repair A/C unit 4. Contact RHS 900 supplier 5. Empty cylinder 6. Contact RHS 900 supplier
Recovery process does not stop	1. Oil drain valve not closed 2. A/C unit leakage 3. Internal component fault	1. Close valve 2. Contact RHS 900 supplier 3. Contact RHS 900 supplier
Recovery process runs only for a short period	1. Valves on service couplings not opened 2. System pressure is 16 bar 3. Internal cylinder full 4. Internal component fault	1. Open valves 2. Contact RHS 900 supplier 3. Empty cylinder 4. Contact RHS 900 supplier

Trouble shooting

Evacuation process:

Problem	Fault	Remedy
Vacuum pump does not run	1. RHS 900 not cut in 2. Overpressure in A/C unit 3. Internal component fault	1. Cut in RHS 900 2. Cut in recovery process 3. Contact RHS 900 supplier
Vacuum pump runs but does not build up enough vacuum	1. Service couplings not fitted correctly 2. A/C unit defective/leaking 3. Internal component fault	1. Fit service couplings correctly 2. Repair A/C unit 3. Contact RHS 900 supplier

Charging process:

Problem	Fault	Remedy
No refrigerant flow	1. High-pressure valve on service coupling not opened 2. Internal component fault	1. Open valve 2. Contact RHS 900 supplier!
Lamps "Vacuum OK" and "Vacuum fault" light up together	1. Solenoid valve Y14 in RHS 900 leaking	1. Replace valve or contact RHS 900 supplier

Pos. no. location

Mecanical diagram

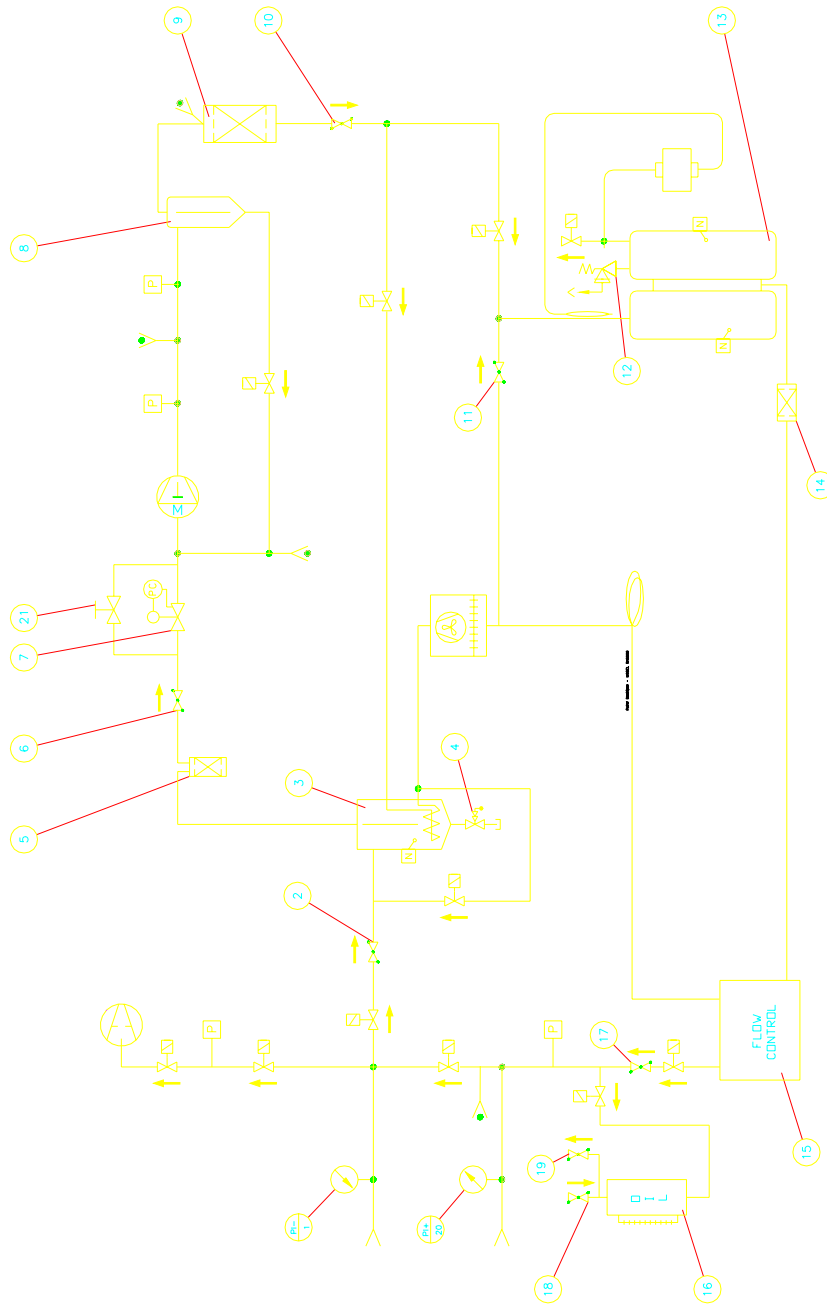

642-120001A-01

Pos. no. location

Electrical diagram:

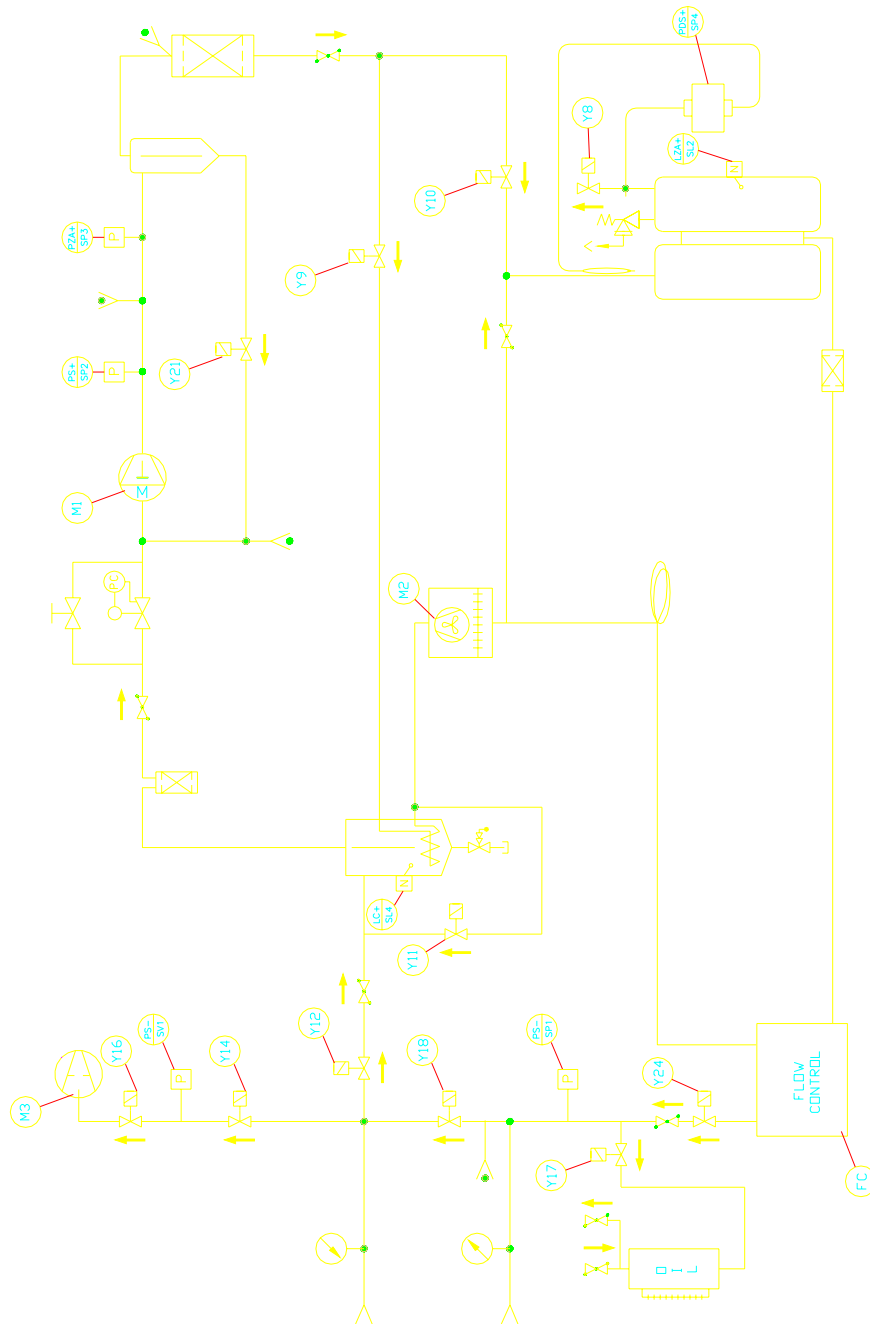

Pos. no. location

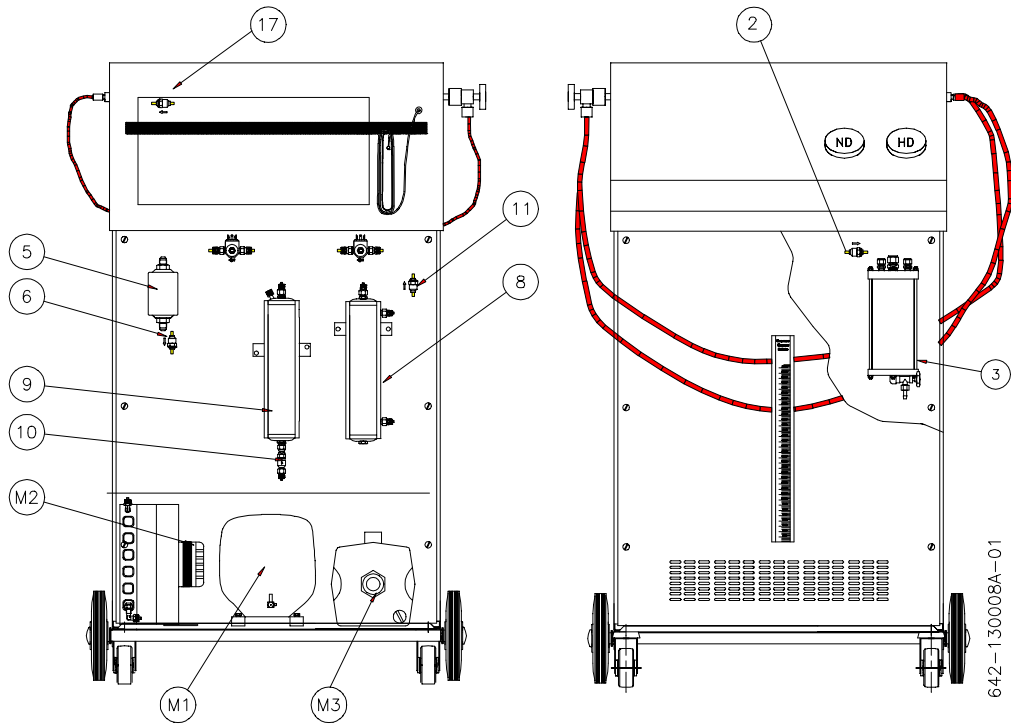

- | | | | |
|----|---------------------|-----|---------------|
| 2) | Check valve | 10) | Check valve |
| 3) | Suction accumulator | 11) | Check valve |
| 5) | Acid filter | 17) | Check valve |
| 6) | Check valve | M1) | Compressor |
| 8) | Oil filter | M2) | Condenser/Fan |
| 9) | Filter drier | M3) | Vacuum pump |

Appendixes

Example of trouble shooting in an A/C unit:

Conditions:

- | | |
|---------------------------------|-------------------|
| 1. Ambient temperature | 30-35°C (86-95°F) |
| 2. Motor speed | 2000 rpm |
| 3. A/C unit temperature setting | Maximum |

Under the above conditions the pressure values for an intact A/C unit will be as follows during the TEST process:

High pressure	15 bar
Low pressure	2 bar

Follow the TEST process as in Section 5:

- Connect service couplings to A/C unit.
- Close high and low-pressure valves on RHS 500.
- Open service coupling valves.
- Start in A/C unit.
- Now the station will perform a test function.
Perform a condition diagnosis for the A/C unit in accordance with supplier instructions.
- Stop A/C unit after the test process has been completed.

Appendixes

Test - 1:

High pressure	8 - 9 bar
Low pressure	Approx. 0.8 bar

Fault/Problem	Symptom	Possible cause	Remedy
Unsatisfactory refrigeration	Conditioned air not cold	Leakage in A/C unit	Locate leak and repair
	Air bubbles in sight glass	Insufficient refrigerant in A/C unit	Replenish with refrigerant

Test - 2:

High pressure	Approx. 20 bar
Low pressure	Approx. 2.5 bar

Fault/Problem	Symptom	Possible cause	Remedy
Unsatisfactory refrigeration		Insufficient condenser cooling	Clean condenser
		Fan does not run	Repair fan
		Condenser performance impaired by oil or dirt deposits	Clean condenser
		Insufficient oil in A/C unit (compressor friction)	Replenish oil
		Refrigerant overcharge	check the refrigerant quantity in the A/C unit - empty the A/C unit, evacuate and recharge thr correct quantity
			If none of these remedies are successful, check the refrigerant quantity in the A/C unit - empty the A/C unit, evacuate and recharge

Test - 3:

Appendixes

High pressure	Approx. 7 - 15 bar
Low pressure	Approx. 1.5 bar

Fault/Problem	Symptom	Possible cause	Remedy
Periodic disturbances in A/C unit	Varying pressure on high and low-pressure sides	Moisture in A/C unit causes ice formation on expansion valve resulting in reduced output, or filter drier saturated.	Empty A/C unit, evacuate and recharge. After the recovery process, replace filter drier. If necessary, remove expansion valve, clean it and refit or replace as necessary.

Test - 4:

High pressure	Approx. 6 bar
Low pressure	Approx. -0.3 bar

Fault/Problem	Symptom	Possible cause	Remedy
Little or no refrigeration from A/C unit	Hoses before or after expansion valve or filter drier covered with moisture or ice	Expansion valve or filter drier blocked with ice because of moisture in A/C unit	Disconnect A/C unit, wait a few minutes and then empty the unit, evacuate and recharge

Appendixes

Test - 5:

High pressure	Approx. 19 - 20 bar
Low pressure	Approx. 2.5 bar

Fault/Problem	Symptom	Possible cause	Remedy
Unacceptable refrigeration	Ice or moisture on hoses on low pressure/suction side of A/C unit	Expansion valve defective or sensor placed incorrectly. Expansion valve opens too much.	Check expansion valve sensor placing. Replace expansion valve.

Test - 6:

High pressure	Approx. 7 - 10 bar
Low pressure	Approx. 4 - 6 bar

Fault/Problem	Symptom	Possible cause	Remedy
A/C unit does not refrigerate	Pressure on low-pressure side too high or pressure on high-pressure side too low	Internal compressor leakage	Repair or replace compressor

Appendixes

Pressure vessel declaration

We confirm herewith that the condition of the pressure vessel in this unit conforms to regulations laid down by the appropriate authorities:

Suction accumulator, pos. 3:

Manufacturer: A'GRAMKOW A/S
Augustenborg Landevej 19
DK-6400 Sønderborg
Denmark

Type: 642-010017A

Permissible working pressure: PS = 25 bar

Permissible working temperature: -40/70°C

Volume: V = 1.53 litres

Oil separator, pos. 8:

Manufacturer: AC & R Components
Chatham, Ill.
USA

Type: S-5920F

Permissible working pressure: PS = 31.05 bar

Permissible working temperature: 10/120°C

Volume: V = 0.83 litres

Appendixes

Filter drier, pos. 9:

Manufacturer:	RTI Technologies Inc.
Type:	026-80044-00
Permissible working pressure:	PS = 31.05 bar
Permissible working temperature:	10/120°C
Volume:	V = 0.83 litres

Charging cylinder, pos. 13

Manufacturer:	Henry Valve (UK)
Type:	642-100027B
Permissible working pressure:	PS = 25 bar
Permissible working temperature:	-20/120°C
Volume:	V = 7.0 litres